

SAM4S

ER-5200 / ER-5200M series Electronic Cash Register AU

Operation and Program Manual

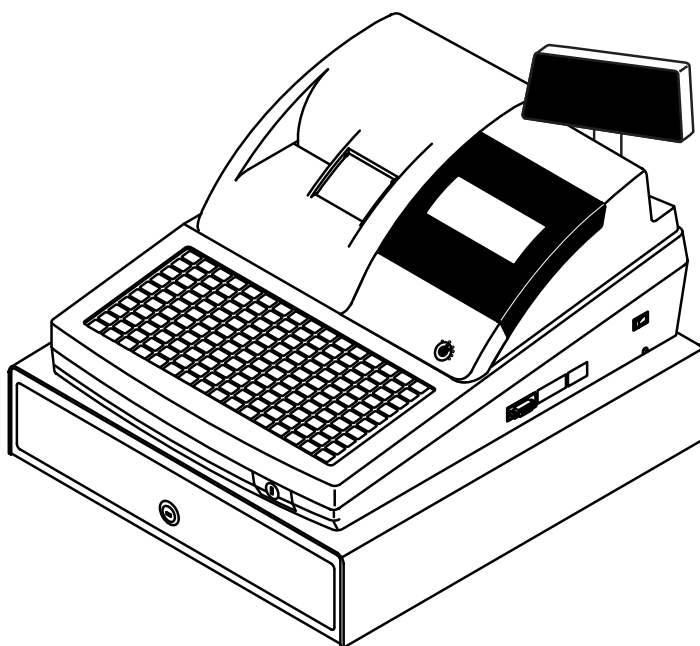

All specifications are subject to change without notice

JK68-60953L(Rev.02)
From *ER-52xx* v1.0, *ER-52xxM* v1.0
Up to *ER-52xx* v5.8, *ER-52xxM* v5.8

ATTENTION

The product that you have purchased contains a rechargeable Ni-MH battery. This battery is recyclable. At the end of its useful life, under various state and local laws, it may be illegal to dispose of the battery into the municipal waste system.

Check with your local solid waste officials for details concerning recycling options or proper disposal.



WARNING

This is a Class A product. In a domestic environment this product may cause radio interference in which case the user may be required to take adequate measures.

Precaution Statements

Follow these safety, servicing and ESD precautions to prevent damage and to protect against potential hazards such as electrical shock.

1-1 Safety Precautions

1. Be sure that all built-in protective devices are replaced. Restore any missing protective shields.
2. When reinstalling the chassis and its assemblies, be sure to restore all protective devices, including nonmetallic control knobs and compartment covers.
3. Make sure there are no cabinet openings through which people - particularly children - might insert fingers and contact dangerous voltages. Such openings include excessively wide cabinet ventilation slots and improperly fitted covers and drawers.
4. Design Alteration Warning:
Never alter or add to the mechanical or electrical design of the SECR. Unauthorized alterations might create a safety hazard. Also, any design changes or additions will void the manufacturer's warranty.
5. Components, parts and wiring that appear to have overheated or that are otherwise damaged should be replaced with parts that meet the original specifications. Always determine the cause of damage or over- heating, and correct any potential hazards.
6. Observe the original lead dress, especially near the following areas: sharp edges, and especially the AC and high voltage supplies. Always inspect for pinched, out-of-place, or frayed wiring. Do not change the spacing between components and the printed circuit board. Check the AC power cord for damage. Make sure that leads and components do not touch thermally hot parts.
7. Product Safety Notice:
Some electrical and mechanical parts have special safety-related characteristics that might not be obvious from visual inspection. These safety features and the protection they give might be lost if the replacement component differs from the original - even if the replacement is rated for higher voltage, wattage, etc.
Components that are critical for safety are indicated in the circuit diagram by shading, () or (). Use replacement components that have the same ratings, especially for flame resistance and dielectric strength specifications. A replacement part that does not have the same safety characteristics as the original might create shock, fire or other hazards.

CAUTION

There is the danger of explosion if battery is incorrectly replaced.

Replace only with the same or equivalent type recommended by the manufacturer.

Dispose used batteries according to the manufacturer's instructions.

ATTENTION

Il y a danger d'explosion s'il y a remplacement incorrect de la batterie.

Remplacer uniquement avec une batterie du même type ou d'un type équivalent recommandé par le constructeur.

Mettre au rebut les batteries usagées conformément aux instructions du fabricant.

SAFETY NOTICE: "For pluggable equipment, the socket-outlet shall be installed near the equipment and shall be easily accessible."

1-2 Servicing Precautions

WARNING: First read the-Safety Precautions-section of this manual. If some unforeseen circumstance creates a conflict between the servicing and safety precautions, always follow the safety precautions.

WARNING: An electrolytic capacitor installed with the wrong polarity might explode.

1. Servicing precautions are printed on the cabinet. Follow them.
2. Always unplug the units AC power cord from the AC power source before attempting to:
 - (a) Remove or reinstall any component or assembly
 - (b) Disconnect an electrical plug or connector
 - (c) Connect a test component in parallel with an electrolytic capacitor
3. Some components are raised above the printed circuit board for safety. An insulation tube or tape is sometimes used. The internal wiring is sometimes clamped to prevent contact with thermally hot components. Reinstall all such elements to their original position.
4. After servicing, always check that the screws, components and wiring have been correctly reinstalled. Make sure that the portion around the serviced part has not been damaged.
5. Check the insulation between the blades of the AC plug and accessible conductive parts (examples: metal panels and input terminals).
6. Insulation Checking Procedure: Disconnect the power cord from the AC source and turn the power switch ON. Connect an insulation resistance meter (500V) to the blades of AC plug.

The insulation resistance between each blade of the AC plug and accessible conductive parts (see above) should be greater than 1 megohm.
7. Never defeat any of the B+ voltage interlocks Do not apply AC power to the unit (or any of its assemblies) unless all solid-state heat sinks are correctly installed.
8. Always connect an instrument's ground lead to the instrument chassis ground before connecting the positive lead; always remove the instrument's ground lead last.

1-3 Precautions for Electrostatic Sensitive Devices (ESDs)

1. Some semiconductor (solid state) devices are easily damaged by static electricity. Such components are called Electrostatic Sensitive Devices (ESDs); examples include integrated circuits and some field-effect transistors. The following techniques will reduce the occurrence of component damage caused by static electricity.
2. Immediately before handling any semiconductor components or assemblies, drain the electrostatic charge from your body by touching a known earth ground. Alternatively, wear a discharging wrist-strap device. (Be sure to remove it prior to applying power - this is an electric shock precaution.)
3. After removing an ESD-equipped assembly, place it on a conductive surface such as aluminum foil to prevent accumulation of electrostatic charge.
4. Do not use Freon-propelled chemicals. These can generate electrical charges that damage ESDs.
5. Use only a grounded-tip soldering iron when soldering or unsoldering ESDs.
6. Use only an anti-static solder removal device. Many solder removal devices are not rated as anti-static; these can accumulate sufficient electrical charge to damage ESDs.
7. Do not remove a replacement ESD from its protective package until you are ready to install it. Most replacement ESDs are packaged with leads that are electrically shorted together by conductive foam, aluminum foil or other conductive materials.
8. Immediately before removing the protective material from the leads of a replacement ESD, touch the protective material to the chassis or circuit assembly into which the device will be installed.
9. Minimize body motions when handling unpackaged replacement ESDs. Motions such as brushing clothes together, or lifting a foot from a carpeted floor can generate enough static electricity to damage an ESD.

Contents

Getting Started	1
About the <i>ER-5200/ER-5200M Series</i>	1
Unpacking.....	2
Installing the Paper	2
Basic Features and Functions	6
Standard Hardware	6
Optional Hardware	6
Software Features	6
Front Display	7
Rear Display - VFD.....	10
Error Code Table	12
Control Lock	13
Keyboards.....	14
Program Overlay	16
Memory Clear	17
Memory All Clear (RAM Clear)	17
Initial Clear (Status Clear).....	19
 Operating Instructions	 21
Function Key Descriptions	21
Clerk Sign-On/Sign-Off	25
Direct Sign-On	25
Coded Sign-On.....	25
Receipt On and Off.....	26
Program 99 - Receipt ON/OFF Programming.....	26
Item Registrations.....	27
Keyboard PLU Entry - Open Price / Preset Price Override	28
Keyboard PLU Entry - Preset Price.....	28
Keyboard PLU Entry - Repeat	29
Keyboard PLU Entry - Multiplication.....	30
Keyboard PLU Entry - Direct Multiplication with Preset Price.....	30
Keyboard PLU Entry - Multiplication with Decimal Point.....	31
Keyboard PLU Entry - Split Pricing	32
Keyboard PLU Entry - Single Item.....	32
Code PLU Entry - Open Price.....	33
Code PLU Entry - Preset Price / Single Item	33
Code PLU Entry - Preset Price Override.....	34

Code PLU Entry - Repeat.....	34
Code PLU Entry - Multiplication	35
Code PLU Entry - Multiplication with Decimal Point	35
Code PLU Entry - Split Pricing.....	36
Barcode PLU Entry - Open Price, Single Item.....	37
Barcode PLU Entry - Open Price, Multiple Items.....	37
Barcode PLU Entry - Preset Price Override, Single Item.....	38
Barcode PLU Entry - Preset Price Override, Multiple Items	38
Modifier Key	39
Price Level Key	40
Promo	41
Waste.....	42
Percent Key Operations	43
Preset Percent Discount on an Item.....	44
Enter a Percent Discount on an Item	44
Preset Percent Discount on Sale Total.....	45
Enter a Percent Discount on Sale Total.....	45
For Surcharge Operation	45
Dollar Amount Discount on Sale.....	46
Dollar Amount Discount on Item	46
Return Merchandise Registrations.....	47
Voids and Corrections	48
Error Correction (Void Last Item).....	48
Void Previous Item.....	48
Cancel.....	49
Void Mode Operations	49
No Sale Operations.....	50
Open Drawer	50
Non Add Number	50
Received On Account Operations.....	51
Paid Out Operations.....	52
Subtotaling a Sale	53
Eat In/Take Out/Drive Thru Sales	53
Totaling and Tendering.....	54
Totaling a Cash Sale.....	54
Totaling a Check Sale.....	54
Tendering a Cash Sale	55
Tendering a Check Sale.....	55
Totaling a Charge (EFTPOS) Sale	56
Tendering a Charge (EFTPOS) Sale	56
Cash Out within a Charge (EFTPOS) Sale.....	57
Check Cashing.....	58
Split Tender	58
Post Tender.....	59
Currency Conversion.....	59
Table Management and Clerk Interrupt Operations	60
Overview	60
Soft Check - Restaurant Style Billing.....	61
Hard Check - Monthly Account Style Billing	66
Scale Entry.....	70
Direct Scale Entry.....	70
Automatic Scale Entry.....	71
Tare Weight Entry	71
Manual Tare Weight Entry.....	72
Manual Weight Entry	73

X/Z Mode	75
Introduction	75
X/Z Reports	76
Running a Report - General Instructions.....	76
Report Table.....	77
Reset Hard Check (Slip) Line # (<i>EPROM v3.4R</i>).....	78
Program 10 - Reset Hard Check Line # Programming.....	78
Cash Declaration.....	79
Program 90 - Cash Declaration Programming	79
Service Mode Programming	81
Overview	81
Memory Allocation Scan.....	82
PC Online Mode	82
Memory Allocation.....	83
Program 60 - Memory Allocation Programming.....	83
Clear All Sales Totals.....	84
Program 20 - Clear All Sales Totals.....	84
Clear Grand Total	84
Program 30 - Clear Grand Total.....	84
Clear / Delete PLU File	84
Program 40 - Clear / Delete PLU File.....	84
EPROM Information	84
Program 50 - EPROM Information	84
Function Key Assignment Programming	85
Program 70 - Function Key Assignment Programming	85
Function Key Codes	86
RS232C Serial Ports Communication Options.....	87
Program 8x - RS232C Serial Ports Communication Options.....	87
Program Mode Programming	91
Default Programming	91
Descriptor Programming Methods.....	91
Alpha Overlay Method.....	92
Descriptor Code Method	93
Tax Programming	94
Straight Percentage Tax Rate Programming	94
PLU Programming.....	96
Program 100 - PLU Status Programming.....	97
Program 110 - PLU Auto Tare Programming	100
Program 150 - PLU Group Assignment Programming	101
Program 200 - PLU Price/HALO Programming	102
Program 250 - PLU Stock Amount Programming	103
Program 300 - PLU Description Programming.....	104
Program 350 - PLU Link Programming.....	105
Program 400 - PLU Delete Programming.....	106
Program 450 - PLU MIX & MATCH Programming	107
System Option Programming.....	108
Program 30 - System Option Programming	108
System Option Table	109
Note: Price Embedded Barcode Format	112
Print Option Programming	113
Program 40 - Print Option Programming	113

Print Option Table	114
Function Key Programming	118
Program 70 - Function Key Options Programming	119
Program 80 - Function Key Descriptor Programming	120
Program 90 - Function Key HALO or Percentage Rate Programming	121
ADD CHECK (Cafeteria Tray Total)	122
CANCEL (Cancel a Sale)	123
CASH	124
CHARGE (1 ~ 8)	125
CHECK (CHEQUE)	126
CHECK (CHEQUE) CASHING	127
CHECK (CHEQUE) ENDORSEMENT	128
CHECK # (Bill or Account)	129
CURRENCY CONVERSION	130
DRIVE THRU / EAT IN / TAKE OUT	131
ERROR CORRECT	132
F/S SUB	132
F/S TEND	133
GUEST (Bill or Account)	134
LEVEL1 - 2 (Price Levels)	134
MACRO (1 ~ 10)	135
MDSE RETURN	135
MODIFIER (1 ~ 5)	136
#/NS (Non Add#/No Sale)	137
PAID OUT (1 ~ 3)	138
PAYMENT (Bill or Account)	138
PBAL (Bill or Account)	139
PRINT CHECK (Bill or Account)	139
PROMO	140
RECD ON ACCT (1 ~ 3)	141
SCALE	142
SERVICE (Bill or Account)	143
SUBTOTAL	144
TABLE (Bill or Account)	144
TARE	145
TAX EXEMPT	146
TIP (Bill or Account)	147
VALIDATE	148
VOID	148
WASTE	149
% (1 ~ 5) (Discounts or Surcharges)	150
Clerk Programming	152
Program 800 - Secret Code Programming	153
Program 801 - Drawer Assignment & Training Clerk Programming	154
Program 810 - Clerk Description Programming	155
Mix & Match Programming	156
Program 600 - Trip Level Programming	157
Program 601 - Price Programming	157
Program 610 - Mix & Match Description Programming	158
Group Programming	159
Program 900 - Group Status Programming	159
Program 910 - Group Descriptors Programming	160
Miscellaneous Programming	161
Program 1500 - Macro Key Sequence Programming	161
Program 700 - Logo Description Programming	162

Program 701 - Financial Report Message Programming	163
Program 710 - Clerk Report Message Programming	165
Program 711 - Macro Name Programming	167
Program 1000 - NLU (Number Look Up) Code Number Programming	168
Program 1100 - Cash-In-Drawer Limit Programming	169
Program 1200 - Check Change Limit Programming	170
Program 1300 - Date and Time Programming	171
Program 1400 - Scale Tare Weight Programming	172
Program 1600 - Machine Number Programming	173
Program Scans	174
Program 15 - Program Scans	174

Sample Reports

177

Financial	177
Time	181
PLU	182
Clerk	183
Individual Clerk	184
Groups	185
Stock	186
Open Check	187

Getting Started

About the *ER-5200/ER-5200M Series*

The *ER-5200/ER-5200M Series* is offered in three different versions.

- The *ER-5200/ER-5200M* features a flat 160 position keyboard with 117 NLU keys. Because it offers protection from spills, this keyboard works best in restaurants, food service shops, or convenience stores where food is served.
- The *ER-5240/ER-5240M* features a 90 position keyboard with traditional raised keys. This keyboard will accommodate up to 40 NLU keys and works best in retail stores, or shops where it is not necessary to place a large number of preset item keys on the keyboard.
- The *ER-5215/ER-5215M* features a 60 position keyboard with traditional raised keys. This keyboard will accommodate up to 15 NLU keys and works best in retail stores, or shops where it is not necessary to place a large number of preset item keys on the keyboard.
- The *ER-5200/ER-5200M Series* has a standard capacity of 1000 PLUs and 20 Groups allows for easy item management. . For expansion to 9000 PLUs, please contact your dealer.
- The *ER-5200/ER-5200M Series*, with its superb thermal printing system, always provides the fastest in transaction speeds.
- The *ER-5200/ER-5200M Series is preset with 10% GST and Australian rounding as well as a number of other useful functions.*

This manual includes instructions for three models. The keyboard is the only significant difference between the three models. All other features are the same, unless otherwise noted.

Unpacking

1. Unpack and unwrap the cash register.
2. Located in the packing are the following items:
 - 2 roll of paper and 1 paper spindle,
 - 2 sets of control keys,
 - Operation and Program Manual,
3. Remove the cardboard protectors from the cash drawer.
4. Plug the register into a grounded outlet (three prong), insert a control key and turn the key to the **REG** control lock position.

Installing the Paper

1. Remove the printer cover.

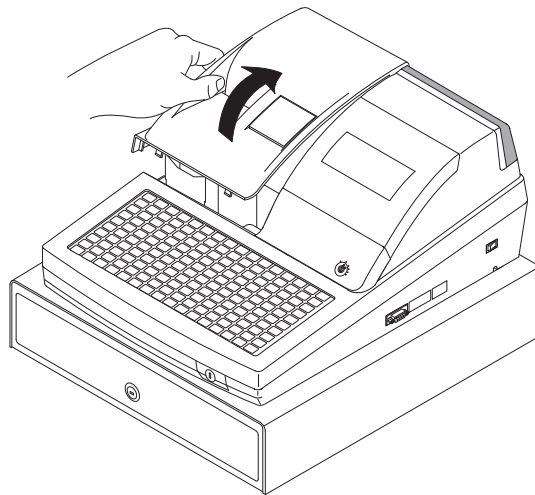

2. Push the blue cap lever and then lift up to open the paper cover.

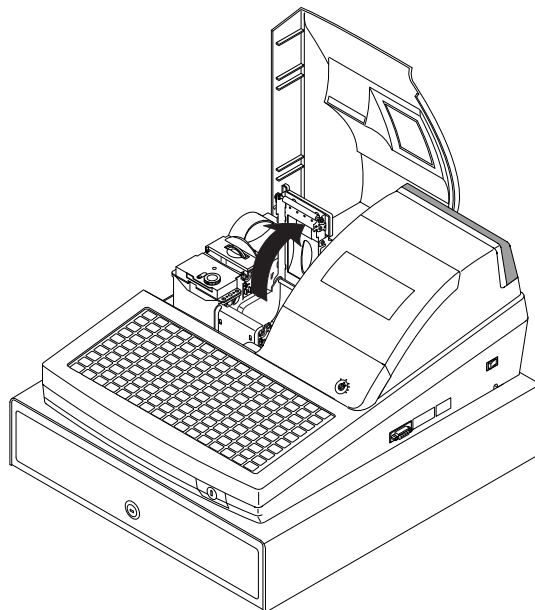
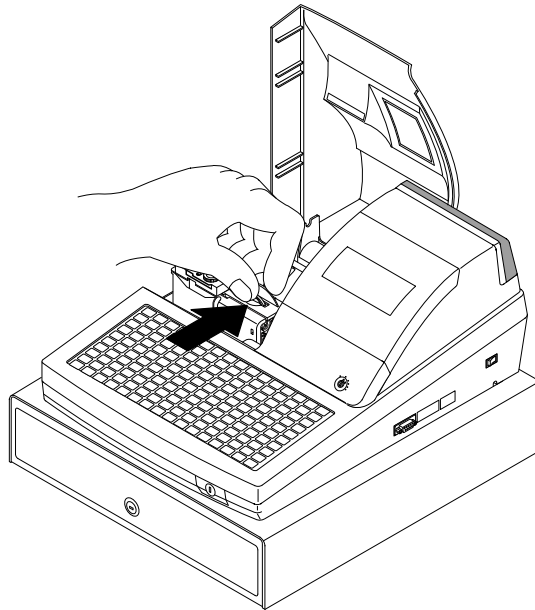

3. Ensure that the paper is being fed from the bottom of the roll.

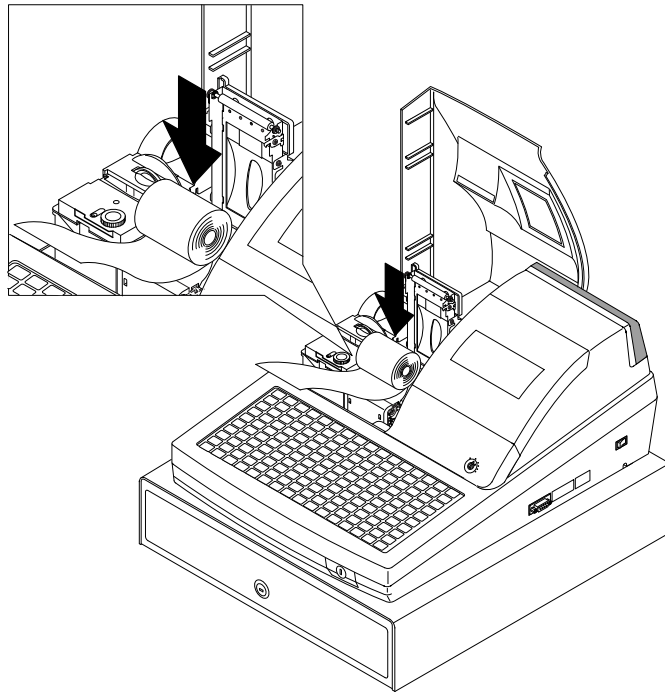

4. Put the the leading edge of the paper over the printer

5. Close the paper cover slowly until it locks firmly

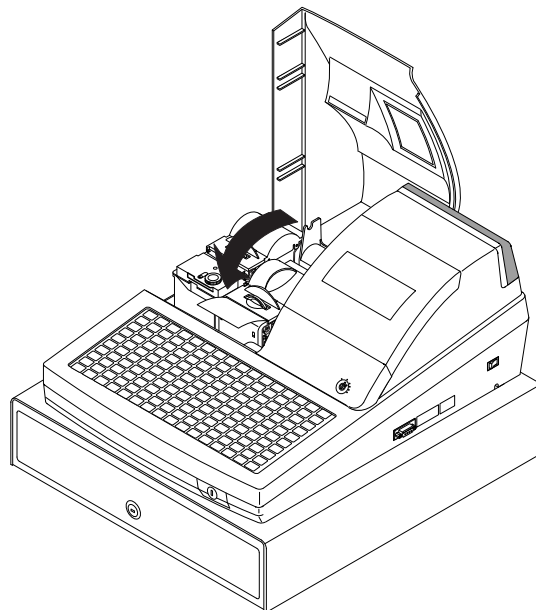

6. Passing the leading edge of the paper through the cutter slot. Tear off the excess paper. Replace the printer cover.

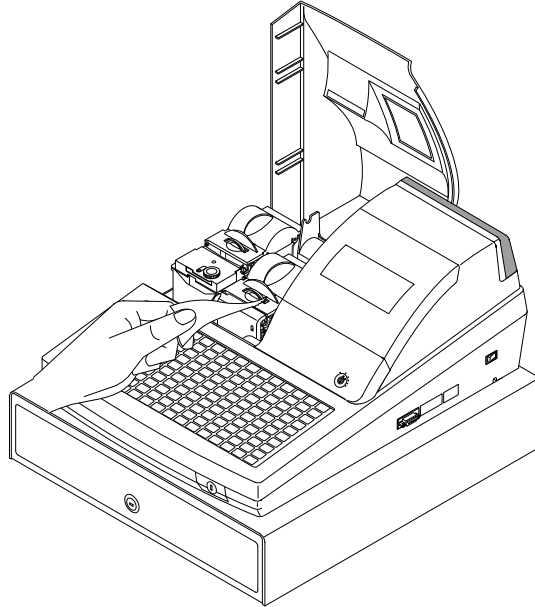

- ※ If you wish to use the printer to print a sales journal, insert the paper into the paper take-up spool. Wind the paper two or three turns around the spool shaft and install the spool in the mount.

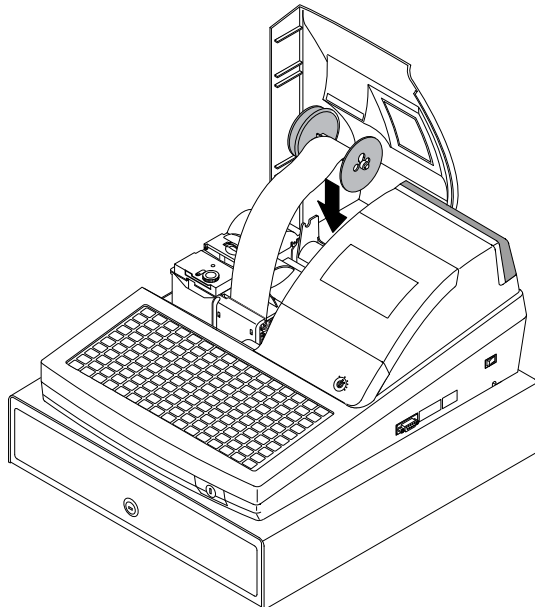

Basic Features and Functions

Standard Hardware

- Display
 - => **ER-52xxM** LCD model: 2 line, 16 character liquid crystal display and ten position rear displays with a rear pop up display standard.
 - => **ER-52xx** VFD model: Ten position front and rear displays with a rear pop up display standard.
- 160(*ER-5200/ER-5200M*),90(*ER-5240/ER-5240M*),60(*ER-5215/ER-5215M*) position keyboard.
- 2 station Thermal 32-column printer with drop-and-print mechanism.
- Sturdy Metal Cash Drawer with removable 4 Bill/8 Coin drawer insert.
- 7-position control lock.
- Standard customer pole display.
- Communications ports: 2 RS232C.

Optional Hardware

- PC Link.
- Load cell scale.
- Kitchen printer / Bill Printer / Slip Printer / Journal Printer.
- Barcode scanner.
- Pole Display.
- EFTPOS Terminal.
- Real clerk keys and lock assembly for 15 clerks.

Software Features

- Up to 2 price levels for each PLU.
- Up to 5 PLU modifier keys.
- **1000** Price Look Ups (PLUs) default (expandable **up to 15,000 with up to two extend memory chips**) for open or preset item registration. **117 PLUs** standard for open or preset item registration. For direct registrations, **up to 117(*ER-5200/ER-5200M*)/up to 40(*ER-5240/ ER-5240M*)/up to 15(*ER-5215/ ER-5215M*)** PLU keys are on the keyboard.
- 18 character programmable descriptors for PLUs and functions.
- Up to 99 PLU Group totals.
- Up to 99 clerks with separate report totals.

Front Display

VFD MODEL – ER-52xx

The *ER-5200/40/15* comes with a ten position front display. Annotations on the display window include:

- **RPT**, where a counter appears when the same item is multiplied or repeated.
- The **AMOUNT** area shows the amount, i.e. price, subtotal or total.
- **RCPT OFF** indicates when the receipt is turned off.
- The **VOID** symbol illuminates during Void operations.
- The **SHIFT** symbol illuminates during Tax Shift operations
- The **CLERK** segment remains illuminated as long as a clerk is signed on.

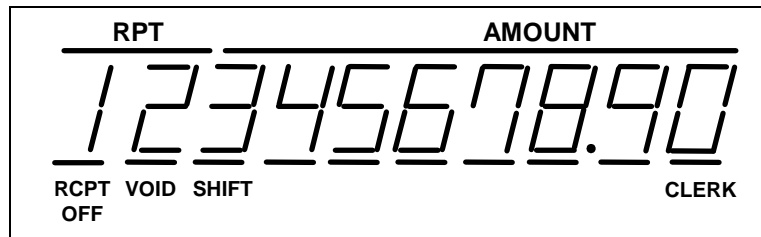

The front display offers supplemental descriptors which appear in the first two display positions (as shown). These descriptors help the operator by supplying additional information while operating the register, and may be accompanied by an error tone. Supplemental descriptors include:

RPT

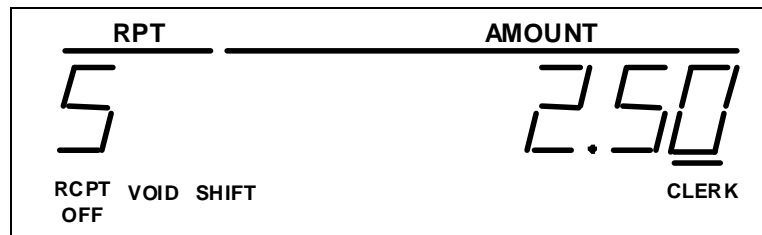

Change Due

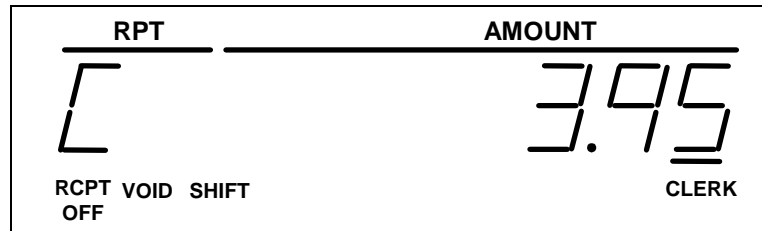

Negative Entry

RPT	AMOUNT
1	-0.75
RCPT OFF	VOID SHIFT CLERK

Subtotal

RPT	AMOUNT
Sub	12.50
RCPT OFF	VOID SHIFT CLERK

Total of Sale

RPT	AMOUNT
—	12.50
RCPT OFF	VOID SHIFT CLERK

Numbered Error Conditions

RPT	AMOUNT
E01	0.00
RCPT OFF	VOID SHIFT CLERK

LCD MODEL – ER-52xxM

The *ER-5200/40/15M* comes with a liquid crystal screen, allowing you to view up to 2 lines of information with up to 20 characters per line. The display is backlit and adjustable to provide excellent visibility, regardless of lighting conditions.

When the control lock is in the OFF position, the register can not be operated. When the control lock in the REG, VOID, X, Z, PGM or SM positions the appropriate message, there are displayed with the message “CLOSED”. You must sign on a clerk to remove the “CLOSED” message and begin operation.

REG

REGISTER MODE CLOSED

VOID

VOID MODE CLOSED

Operator Display Example

- ◆ Press **1 0 0 0**, then **PLU12** to register a sale of \$10.00 to PLU 12

PLU12	
1	10.00

- ◆ Press **5 0 0 0**, then **CASH** to tender a sale and change will be shown

CASH	50.00
CHANGE	40.00

Displayed Error Conditions

** WARNING! ** SEQUENCE ERR
--

Rear Display - VFD

The rear display is a 10 digit florescent display that allows your customer to monitor the transaction and view the sale total. The rear display can be lifted and turned for easy customer viewing.

Rear Display Information

Item Count	The number of times an item has been repeated is displayed
Amount	The amount of the item, subtotal or total, is displayed in the rightmost portion of the display



Rear Display Message

RPT

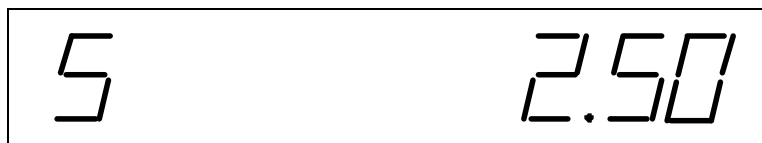

Change Due



Negative Entry

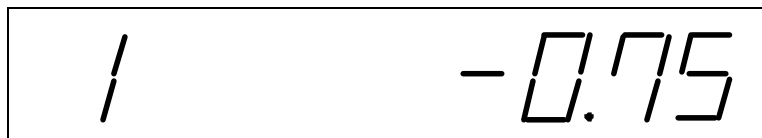

Subtotal



Total of Sale

= 12.50

Numbered Error Conditions

E01 0.00

Error Code Table

E00	SEQUENCE ERROR	E23	CONSOL OVER
E01	PLU NO DATA	E24	REQ. SUBTOTAL
E02	CLERK ERROR	E25	PROMO ERROR
E03	AMOUNT COUNT OVER	E26	CHECK OPEN
E04	LAN TRAN	E27	REQ. PASSWORD
E05	COMMUNICATION ERROR	E28	NO VOID PLU
E06	TIME AND DATE	E29	232C SETUP ERROR
E07	LIMIT OVER	E30	REQ. PRESET VALUE
E08	INACTIVE	E31	REQ. OPEN VALUE
E09	XMODE ONLY	E32	REQ. AMOUNT
E10	NONADD	E33	REQ. PAYMENT
E11	ADDCHECK ERROR	E34	INVALID FUNCTION
E12	CONDIMENT ERROR	E35	REQ. TABLE
E13	REQ. EAT IN	E36	REQ. PBAL
E14	REQ. STOCK	E37	REQ. CHECK #
E15	REQ. DRAWER	E38	ONLY ONE TABLE
E16	REQ. GUEST	E39	REQ. VALID
E17	SCALE	PER	RECEIPT PRINTER PAPER END
E18	CLERK NOT MATCH	PEJ	JOURNAL PRINTER PAPER END
E19	COMPULSORY TARE	PNR	RECEIPT PRINTER NEAR END
E20	REQ. DECLARATION	PNJ	JOURNAL PRINTER NEAR END
E21	OFF LINE	PCO	PRINTER COVER OPEN
E22	REQ. ENDORSEMENT	ACJ	CUTTER JAM
A []	SYSTEM OPTION ERROR (No Auto Cutter installed Set System Option# 24 = 0)		
SLIP CHG	SLIP PAPER END. CHANGE NEW SLIP PAPER (When using slip printer.)		
PFP	SYSTEM ERROR (If this problem occurs, call the service engineer.)		

Control Lock

The control lock has 7 positions, accessed with 5 keys. Each ECR is shipped with two full sets of keys.

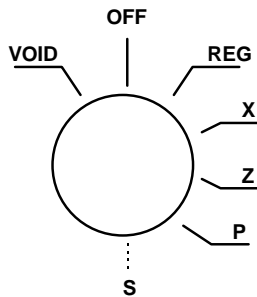

- VOID** Use to void (correct) items outside of a sale.
- OFF** The register is inoperable.
- REG** Use for normal registrations.
- X** Use to read register reports.
- Z** Use to read register reports and reset totals to zero.
- P** Use to program the register.
- S** The S position is a hidden position reserved for dealer access.

Before performing any operations in Register Mode a clerk must be signed on. See “Clerk Sign-On/Sign-Off” for a description of clerk operations.

Control Keys

The *ER-5200/ER5200M Series* includes two sets of keys that may be used to access the following control lock positions.

Key	Positions Accessible						
	VOID	OFF	REG	X	Z	PGM	S
Removable		√	√				
REG		√	√				
VD	√	√	√	√			
Z	√	√	√	√	√		
P	√	√	√	√	√	√	
C	√	√	√	√	√	√	√

Keyboards

ER-5200/ER-5200M Keyboard

The **ER-5200/ER-5200M** keyboard includes 160 key positions with the default legends and key assignments as shown below. This configuration has 117 keyboard NLU locations. The keyboard legend sheet can be replaced by lifting the protective plastic cover.

Programmable key locations are shown with a **bold** border.

RECT FEED	DETL FEED	RCPT ON/OFF										TAX 1	ADD CHECK 6	PAID OUT 12	CLERK 18
												% 1 2	CHECK # 7	RECD ACCT 13	CONV1 19
												% 2 3	SERVIC E 8	VOID 14	CONV2 20
												% 3 4	ERROR CORR 9	RETURN 15	EAT IN 21
												VALID 5	#/NS 10	CANCEL 16	TAKE OUT 22
												CLEAR 11	PLU 17	X/TIME 17	CHARG E2 23
												7	8	9	CHARG E1 24
												4	5	6	CHECK 25
												1	2	3	SBTL 26
												0	00	.	CASH 27

ER-5240/ER-5240M Keyboard

The *ER-5240/ER-5240M* keyboard includes 90 key positions with the default legends and key assignments as shown below. This configuration has 40 keyboard NLU locations. The keyboard legend label can be replaced by removing the protective plastic key cap.

Programmable key locations are shown with a **bold border**.

RECT FEED	DETL FEED	RCPT ON/OFF	#/NS 10	TAX 13	CHECK #	SERVIC E 14	RECD ACCT 15	PAID OUT 16	PRINT CHECK 17	ADD CHECK 18	CONV1 19	CONV2 20	EAT IN 21	CLERK 24
ERROR CORR 1	PLU 6	CLEAR	X/TIME 12	5	10	15	20	25	30	35	40	TAKE OUT 22	CHARG 25 2	
VOID 2		7	8	9	4	9	14	19	24	29	34	39	DRIVE THRU 23	CHARG 26 1
% 1 3	RETURN 7	4	5	6	3	8	13	18	23	28	33	38	CHECK 27	
% 2 4	CANCEL 8	1	2	3	2	7	12	17	22	27	32	37	SBTL 28	
% 2 5	VALID 9	0	00	.	1	6	11	16	21	26	31	36	CASH 29	

ER-5215/ER-5215M Keyboard

The *ER-5215/ER-5215M* keyboard includes 60 key positions with the default legends and key assignments as shown below. This configuration has 15 keyboard NLU locations. The keyboard legend label can be replaced by removing the protective plastic key cap.

Programmable key locations are shown with a **bold border**.

RECT FEED	DETL FEED	RCPT ON/OFF	PLU	RECD ACCT	PAID OUT	CHECK #	SERVICE	PRINT CHECK	CLERK
ERROR CORR	VALID	CLEAR	#/NS	X/TIME	5	10	15	EAT IN	ADD CHECK
VOID	TAX	7	8	9	4	9	14	TAKE OUT	CHARG 2
CANCEL	RETURN	4	5	6	3	8	13	DRIVE HRU	CHARG 1
% 1	CONV 1	1	2	3	2	7	12	SBTL	CHECK
% 2	CONV 2	0	00	.	1	6	11	CASH	

Program Overlay

ER-5200/ER-5200M Alpha Keyboard Overlay

!	@	#	\$	%	^	&	*	()	-	+				
Q	W	E	R	T	Y	U	I	O	P	<	>				
A	S	D	F	G	H	J	K	L	;	'	?	CLEAR		X/TIME	
Z	X	C	V	B	N	M	,	.	/	:	=	7	8	9	
CAPS	DOUBLE	SPACE	SPACE	SPACE	SPACE	SPACE	CAPS	DOUBLE	BACK SPACE	"		4	5	6	
												1	2	3	SBTL
												0	00	.	CASH

ER-5240/ER-5240M Alpha Keyboard Overlay

					!	@	#	\$	%	^	&	*	()	
		CLEAR	X/TIME	Q	W	E	R	T	Y	U	I	O	P		
		7	8	9	A	S	D	F	G	H	J	K	L	;	
		4	5	6	Z	X	C	V	B	N	M	,	CHECK		
		1	2	3	-	+	<	>		?	:	=	SBTL		
		0	00	.	CAPS	DOUBLE	SPACE	DOUBLE	BSPACE	"	.	/	CASH		

There is NO Alpha Keyboard Overlay for ER-5215/ER-5215M

Memory Clear

Memory All Clear (RAM Clear)

CAUTION: The procedures described in this area are security sensitive. Clearing all or parts of the *ER-5200/ER-5200M series* memory may cause damage or loss to the program. Do not share this information with unauthorized users and distribute the special SERVICE-Mode key (C-Key) only to those you may want to perform these functions.

Perform "Clear All Totals", or "Clear PLU File" if you wish to clear only parts of *ER-5200/ER-5200M series* memory. Complete clearing of all memory areas and installation of the default program can be done through the following special procedure:

To Perform a Memory All Clear (reset memory completely):

1. Turn the power switch located on the right side of the register to the **OFF** position.
2. Turn the control lock to the **S-Mode** (one passed PGM-Mode as a **hidden position**).
3. Press and hold the key position where the **CHECK** key (circled key) is located on the default keyboard layout.
4. Continue to hold the **CHECK** key while turning the power switch to the **ON** position.
5. After hear BEEP, release the **CHECK** key.
6. For *ER-5200/ER-5200M* press the **upper left key** (RECT FEED) of the keyboard, then the **lower left key** (PLU 9), then the **upper right key** (CLERK), and finally press the **lower right key** (CASH).

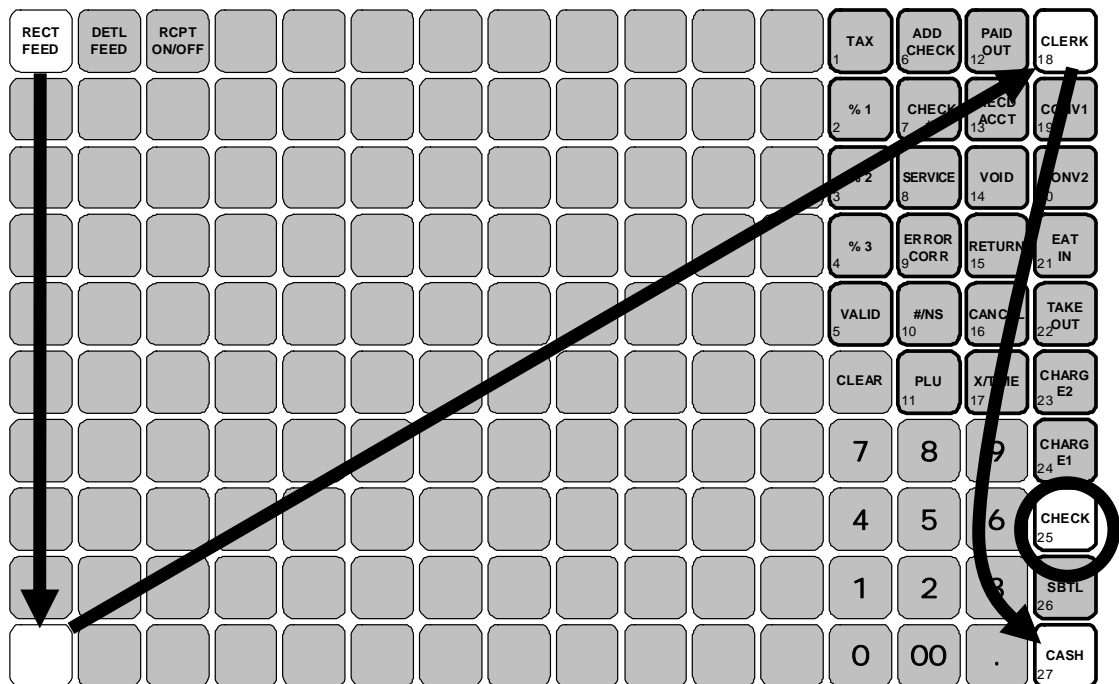

For ER-5240/ER-5240M press the **upper left key** (RECT FEED) of the keyboard, then the **lower left key** (%3), then the **upper right key** (CLERK), and finally press the **lower right key** (CASH).

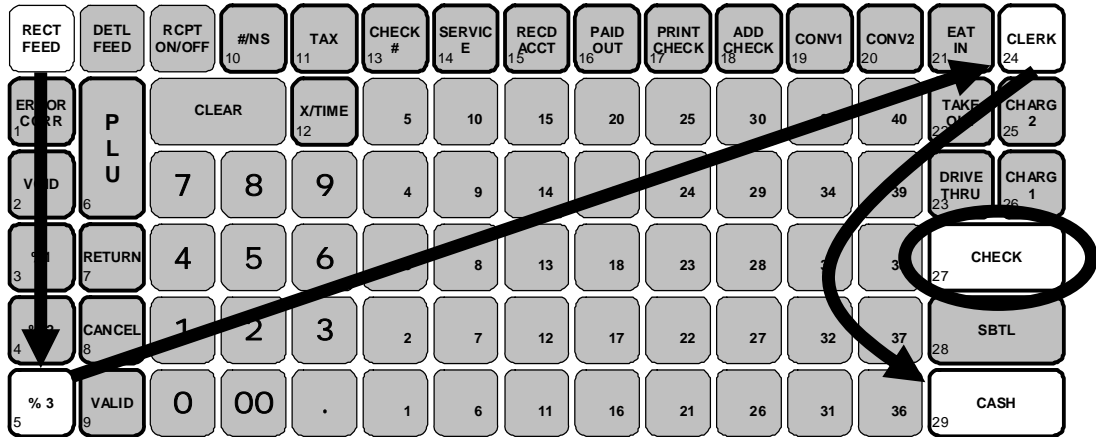

For ER-5215/ER-5215M press the **upper left key** (RECT FEED) of the keyboard, then the **lower left key** (%3), then the **upper right key** (CLERK), and finally press the **lower right key** (CASH).

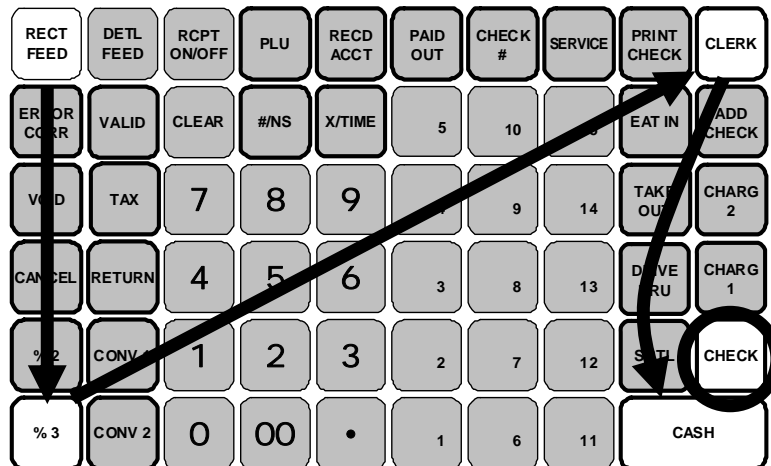

7. When memory is cleared, the register prints a message “RAM ALL CLEAR OK!”

Initial Clear (Status Clear)

CAUTION: Do not share this information with unauthorized users. Distribute the S Mode and/or P Mode key only to those you may want to perform this function.

The initial clear function allows you **to exit any register activity and return to a beginning or cleared state**. Any transaction that is in progress will be exited and totals for that transaction **will not be updated**.

Here are some reasons you may want to perform an initial clear:

- The register is in an unknown state, and you wish to exit the current program or transaction without following normal procedures.
- You have performed a function that includes a compulsory activity and you wish to bypass the compulsion.
- An initial clear may be necessary as part of servicing, or troubleshooting.

To Perform an Initial Clear (program restart):

1. Turn the power switch located on the right side of the register to the **OFF** position.
2. Turn the control lock to the **PGM-Mode**.
3. Press and hold the key position where the **SBTL** key is located on the default keyboard layout.
4. While continuing to hold the **SBTL** key, turn the power switch to the ON position.
5. The message "**INITIAL CLEAR OK!**" prints when the initial clear is complete.

Operating Instructions

Function Key Descriptions

Keys are listed in alphabetical order. Some of the keys described below are not included on the default keyboard. See “**Function Key Assignment Programming**” to add or change programmable keys.

Keyboard Legend	Description
#/NS (#/No Sale)	Use as a non-add key to print up to an 8-digit numeric entry on the receipt. This entry will not add to any sales totals. The #/NS key is also used to open the cash drawer without making a sale.
X/TIME	Use to multiply a quantity of items or calculate split pricing on PLU entries. <i>Also</i> use to display time.
00, 0 - 9, Decimal	Use to make numeric entries in REG, X, Z, VOID, or P positions. The decimal key is used for decimal or scale multiplication, when setting or entering fractional percentage discounts, or when programming fractional tax rates. Do not use the decimal key when making amount entries into PLUs.
ADD CHECK	Use to combine individual trays (in a cafeteria situation) that will be paid together. Each tray subtotal can advance the consecutive number, depending on programming.
CANCEL	Cancels a transaction without updating PLU, or function key totals. The Cancel function may only be used prior to tendering. Once tendering begins, the Cancel function may no longer be used. The CANCEL key corrects the appropriate totals and counters and the Financial report records total of transactions canceled.
CASH	Calculates the sale total including tax, finalizes the sale, and opens the cash drawer. Change computation is allowed by entering an amount before pressing the CASH key. The cash drawer will open only if the amount tendered is equal to or greater than the total amount of the sale. Post tendering is also available should a second change calculation be necessary. Re-enter the tendered amount and press the CASH key to show the new change computation. Press the CASH key a second time to issue a buffered receipt (up to 200 lines) when the receipt on/off function is OFF.
CASH OUT	Use to allow cash out function when EFTPOS terminal is connected and activated. 0(zero) amount cash out will generate a sequence error. This function only allowed within a sale.

Keyboard Legend	Description
CHARGE (1 - 8) or EFTPOS	Use to finalize charge sales. Calculates the sale total including tax, finalizes the sale, and opens the cash drawer. Change computation is allowed by entering an amount before pressing the CHARGE key. The cash drawer will open only if the amount tendered is equal to or greater than the total amount of the sale. Change issued will be subtracted from the cash-in-drawer total.
CHECK (CHEQUE)	Use to finalize check sales. Calculates the sale total including tax, finalizes the sale, and opens the cash drawer. Change computation is allowed by entering an amount before pressing the CHECK key. The cash drawer will open only if the amount tendered is equal to or greater than the total amount of the sale. Change issued will be subtracted from the cash-in-drawer total.
CHECK (CHEQUE) CASHING	Use to exchange a check for cash. Cash-in-drawer and check-in-drawer totals are adjusted.
CHECK (CHEQUE) ENDORSEMENT	Use to print a check endorsement message on an optional slip printer to program an endorsement message.
CHECK #	The CHECK # key is used to begin a new, or access an existing balance (hard check) or itemized bill (soft check.) Check track numbers that are entered manually may be set at a fixed length of one to nine digits. Check track numbers assigned automatically will begin with #1. Existing checks are accessed by entering the check track number and pressing the CHECK # key.
CLEAR (Esc)	Use to clear entries made into the 10 key numeric pad or X/TIME key before they are printed. Also used to clear error conditions.
CLERK	The register will not operate in register mode unless a clerk has been signed on. Clerk sign-on is accomplished by "direct" or "secret code" sign-on. All entries made on the register will report to one of the 15 clerk totals. When a clerk is signed on, all entries following will add to that clerk's total until another clerk is signed on. However, a clerk cannot be changed in the middle of a transaction. To sign a clerk off, thereby displaying the "CLOSED" message on the display, enter 0, and then press the CLERK key. This disables the register until another clerk is signed on. The current clerk must first be signed off before another clerk may be signed on.
CONV (1 - 4)	The currency conversion function, allowed after subtotal, converts and displays the new subtotal at a preprogrammed exchange rate. Tendering is allowed after using the currency conversion function. Change is calculated and issued in home currency. The amount of foreign currency tendered is stored in a separate total on the Financial report, but not added to the drawer total.
EAT-IN TAKE OUT DRIVE THRU	Eat-In, Take Out and Drive Thru are subtotal functions. In areas that have different tax rules for eat-in and take out sales, the EAT-IN , TAKE OUT and DRIVE THRU keys can be programmed to automatically charge or exempt taxes. Sales may not be split between Eat-In, Take Out and Drive Thru. The EAT-IN , TAKE OUT and DRIVE THRU keys maintain separate totals on the Financial report.
ERROR CORR	Use to correct the last entry. The ERROR CORR key corrects the appropriate totals and counters.
F/S SHIFT	When pressed before a PLU entry, the F/S SHIFT key reverses the preprogrammed food stamp status of the PLU. For example, an item not food stamp eligible can be made food stamp eligible.
F/S SUB	Displays the amount of the sale that is food stamp eligible.
F/S TEND	Use to tender food stamps for eligible sales.

Keyboard Legend	Description
GUEST #	Use to enter the count of guests served as part of a guest check.
INACTIVE	Use to inactivate the key on the keyboard with warning/error message.
JFEED (JOURNAL FEED)	Advances the journal printer paper one line, or continuously until the key is released.
LEVEL (1 – 2)	Use to switch between different price levels if price level 2 is activated.
MACRO (1 - 10)	Macro keys may be programmed to record, and then later perform, up to 50 keystrokes. For example, a macro key could be set to tender (preset tender) a common currency, such as \$5 into the cash key.
MODIFIER (1 – 5)	The Modifier key alters the next PLU registered, either by changing the Code number of the PLU so that a different item is registered, or by adding the modifier descriptor.
P/BAL	Use to enter the amount of an outstanding balance.
PAID OUT (1 – 3)	Use to record money taken from the register to pay invoices, etc. The paid out amount subtracts from the cash-in-drawer total. Paid outs are allowed outside of a sale only.
PAYMENT	Allows part payment of bill.
PFEED (RECEIPT FEED)	Advances the receipt printer paper one line, or continuously until the key is released.
PLU	The PLU key is used to register price look-ups by number entry. PLUs can be programmed open or preset, and positive or negative.
PRICE INQUIRY	Used to check the price of PLU.
PRINT CHECK	Use to print a guest check. The check can be printed on an optional (RS-232C) printer, or can be printed on the receipt printer. The PRINT CHECK key can be set to automatically service the check.
PROMO	The PROMO key allows you to account for promotional items, as in "buy two, get one free". Pressing this key will remove an item's cost from the sale, but will include the sale of the item in the item's sales counter.
RCPT ON/OFF (RECEIPT ON/OFF)	Use to switch receipt printer on/off.
RECD ACCT (1 – 3)	The RECD ACCT (received on account) key is used to record media loaned to the cash drawer, or payments received outside of a sale. The cash drawer will open. The amount received adds to the cash-in-drawer total.
RETURN	Used to return or refund merchandise. Returning an item will also return any tax that may have been applied.
SCALE	Use to make weight entries. When a scale is attached, press the scale key to show the weight in the display, then press (or enter) a PLU to multiple the weight times the price. When a scale is not attached, you can enter the weight (using the decimal key for fractions). PLUs may be programmed to require an entry through the scale key.
SERVICE (New Balance)	Use to temporarily finalize Previous Balance or Table tracking transactions.
SUBTOTAL	Displays subtotal of sale including tax. Must be pressed prior to a sale discount or sale surcharge.
TABLE #	Tracks the current balance for a guest check or table.

Keyboard Legend	Description
TARE	Tares are container weights. If you are using the scale function, you can preset up to 5 different tare weights. The tare can be subtracted automatically when a specific PLU is registered, or manually inputting the tare number and pressing the TARE key can subtract the tare. Tare #5 can be programmed for entering tare weights manually.
TAX EXEMPT	Press the TAX EXEMPT key to exempt tax 1, tax 2, tax 3, and/or tax 4 from the entire sale.
TAX SHIFT (1 - 4)	When pressed before a PLU entry, the tax shift keys reverse the tax status of the PLU, i.e., a PLU with non-tax status would become taxable or a PLU with tax status would become non-taxable.
TIP	The TIP key allows a gratuity to be added to a guest check before payment. The tip amount is deducted from the Cash-in-Drawer amount for the Clerk/Cashier closing the guest check. The TIP key may be programmed as either a percentage or amount. If programmed as a percentage, tax programming defines whether the percentage is calculated on the net amount or the amount after taxes.
VOID	Use to correct an item entered earlier within a sale. The VOID key corrects the appropriate totals and counters. To correct the last item, use the ERROR CORR key. For void operations outside of a sale (Transaction Void), use the VOID position on the control lock. The Financial report records totals for each type of void separately.
VALID	Press the VALID key to print a one-line validation on a separate form or piece of paper. Any item registration, discount or payment may be validated.
WASTE	The WASTE key allows control of inventory by accounting for items that must be removed from stock due to spoilage, breakage or mistakes. Press the WASTE key before entering wasted items, and then press the WASTE key again to finalize. The WASTE key may be under manager control, requiring the control lock to be in the X position. The WASTE key is not allowed within a sale.
% (1 - 5) (percentage or dollar amount; and discount or surcharge)	Up to five % keys may be placed on the keyboard. Each % key is set with a specific function, such as item discount or surcharge, or sale discount or surcharge. The percent rate may be entered or preprogrammed, or the percent keys can be programmed with a negative open or preset price, thus acting as coupon keys. A percentage key may also be set up to accept charge tip entries.

Clerk Sign-On/Sign-Off

See "System Option Programming" to review your clerk options:

- **System option #2** allows you to select direct or code entry sign on.
- **System option #3** allows you to select stay-down or pop-up operation.

Depending on how your machine has been programmed, sign-on will take place only at the beginning of a shift (stay-down), or may have to be repeated for each transaction (pop-up). If your machine has been programmed for stay-down clerks, the clerk currently signed on must be signed off before another clerk may be signed on.

Check with your store manager to see which options have been selected for your register.

Before any transaction may take place, a clerk must be signed on. Clerk sign-on is accomplished in one of two ways:

To sign On/Off Clerk, need to turn control lock to **REG-Mode**.

Direct Sign-On

To sign on a clerk, enter the clerk number and press the **CLERK** key.

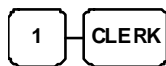

Clerk # (1 - 15)

To sign the clerk off, enter 0 (Zero) and press the **CLERK** key.

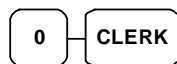

Coded Sign-On

To sign on a clerk, press the **CLERK** key, enter the clerk code, and then press the **CLERK** key again.



Clerk Code (up to 6 digits)

When Clerk Interrupt is activated (please see "Table Management and Clerk Interrupt Operations" in Operation Instructions), to sign on a clerk is enter the clerk code then press the **CLERK** key.



Clerk Code (up to 6 digits)

To sign the clerk off, enter 0 (Zero) and press the **CLERK** key.

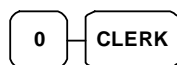

Receipt On and Off

The **RECEIPT ON/OFF** function key may or may not be located on your keyboard.

If the RECEIPT ON/OFF Key is located on the keyboard

1. Press the **RECEIPT ON/OFF** key once to turn the receipt *off*.
2. Press the **RECEIPT ON/OFF** key again to turn the receipt *on*.

Please refer to “**S-Mode Programming - Function Key Assignment**” for detail.

OR

If The RECEIPT ON/OFF Key is NOT located on the keyboard

Program 99 - Receipt ON/OFF Programming

1. Turn the control lock to the **X** position.
2. To turn the receipt *off*, enter **9 9**, press the **SBTL** key. Enter **1**, press **CASH**.



3. To turn the receipt *on*, enter **9 9**, press the **SBTL** key. Enter **0**, press **CASH**.



Item Registrations

All registrations on *ER-5200/ER-5200M Series* are made into open or preset PLUs.

- In place of traditional PLU keys, some PLUs are located directly on the keyboard.
- When more items or categories are needed than the number of PLUs available on the keyboard, registrations can be into PLUs by entering the PLU code number and pressing the **PLU** key on the keyboard.
- The buffer for item registration is fixed **100 lines**.

This system simplifies reporting by listing all items (regardless of how they are entered) on the PLU report, while reporting for groups of items or categories is available from the Group report.

To perform a item registration, need to turn control lock to **REG-Mode** if there is no specific instruction given.

Keyboard PLU Entry - Open Price / Preset Price Override

1. Enter an amount on the number pad. *Do not use the decimal key.*

For example, for \$2.99, enter:

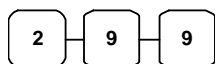

2. Press a PLU.

For example, press PLU 1:

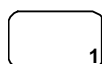

Receipt Example:

THANK-YOU		
CALL AGAIN		
DATE	15/01/2003 WED	TIME 08:33
PLU1 T1		\$2.99
GST		\$0.18
TOTAL		\$3.17
CASH		\$3.17
CLERK 1	No.000011	00001

Keyboard PLU Entry - Preset Price

A preset PLU registers the price that was previously programmed for the PLU. See "**PLU Programming**" in the "**Program Mode Programming**" chapter to program preset prices.

1. Press a preset PLU.

For example, press PLU 5:

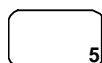

Receipt Example:

THANK-YOU		
CALL AGAIN		
DATE	15/01/2003 WED	TIME 08:33
PLU5		\$1.29
TOTAL		\$1.29
CASH		\$1.29
CLERK 1	No.000011	00001

Keyboard PLU Entry - Repeat

Open or preset price PLUs can be repeated as many times as necessary by pressing the same PLU again. The number of times the item is repeated is shown on the display.

1. Enter an amount on the number pad. **Do not use the decimal key.**

For example, for \$2.99, enter:

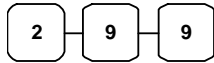

2. Press a PLU.

For example, press PLU 1:

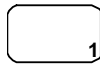

3. To register a second item exactly as the first, press the PLU a second time.

For example, press PLU 1:

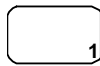

Receipt Example:

THANK-YOU		
CALL AGAIN		
DATE 15/01/2003 WED	TIME 08:33	
PLU1 T1		\$2.99
PLU1 T1		\$2.99
GST		\$0.36
TOTAL		\$6.34
CASH		\$6.34
CLERK 1	NO.000011	00001

Keyboard PLU Entry - Multiplication

When several of the same items are to be entered into the same PLU, you can use multiplication. You can enter a quantity (1 to 999.999) using the **X/TIME** key. You can multiply open or preset PLUs.

1. Enter the quantity of items being purchased, and then press the **X/TIME** key.

For example, enter **4** on the numeric key pad and press the **X/TIME** key:

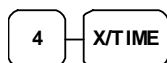

2. Enter an amount on the number pad. *Do not use the decimal key.*

For example, for \$1.99, enter:

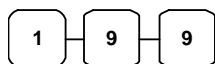

3. Press a PLU.

For example, press PLU **1**:

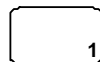

Receipt Example:

THANK-YOU		
CALL AGAIN		
DATE 15/01/2003 WED	TIME 08:33	
4X	@1.99	
PLU1 T1		\$7.96
GST		\$0.48
TOTAL		\$8.44
CASH		\$8.44
CLERK 1	No.000011	00001

Keyboard PLU Entry - Direct Multiplication with Preset Price

When “**Direct Multiply**” (System Option #18-1) is set to yes, you can multiply the preset price PLU directly when **number of item is up to 9**. When “**Direct Multiply more than one digit**” (System Option #20-1) is also set to yes, you can then multiply **more than 9 items** directly when PLU is preset price.

1. Enter the quantity of items being purchased.

For example, enter **4** on the numeric key pad.



2. Press a PLU.

For example, press PLU **1**:

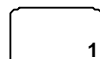

Receipt Example:

THANK-YOU		
CALL AGAIN		
DATE 15/01/2003 WED	TIME 08:33	
4X	@1.99	
PLU1 T1		\$7.96
GST		\$0.48
TOTAL		\$8.44
CASH		\$8.44
CLERK 1	No.000011	00001

Keyboard PLU Entry - Multiplication with Decimal Point

If you are selling items by weight or by length etc., you can multiply a fraction of a unit. It is up to 3 digits after decimal places.

1. Enter the amount with the decimal point, and then press the **X/TIME** key.

For example, for 3.75 kilos of produce, enter:

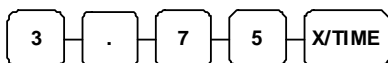

2. Enter an amount on the number pad. **Do not use the decimal key.**

For example, if the price is \$.99 per kilo, enter:



3. Press a PLU.

For example, press PLU 1:



Receipt Example:

THANK-YOU		
CALL AGAIN		
DATE 15/01/2003 WED	TIME 08:33	
3.75X	@0.99	
PLU1 T1		\$3.71
GST		\$0.22
TOTAL		\$3.93
CASH		\$3.93
CLERK 1	NO.000011	00001

Keyboard PLU Entry - Split Pricing

When items are priced in groups, i.e. 3 for \$1.00, you can enter the quantity purchased and let the register calculate the correct price.

1. Enter the quantity purchased, and then press the **X/TIME** key.

For example, enter:



2. Enter the quantity of the group price, and then press the **X/TIME** key.

For example, if the items are priced 3 for \$1.00, enter:

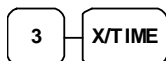

3. Enter an amount on the number pad.

For example, if the items are priced 3 for \$1.00, enter:

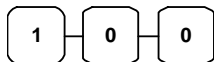

4. Press a PLU.

For example, press PLU 1:

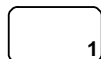

Receipt Example:

THANK-YOU		
CALL AGAIN		
DATE 15/01/2003 WED	TIME 08:33	
2@3FOR	@1.00	
PLU1 T1		\$0.67
GST		\$0.04
TOTAL		\$0.71
CASH		\$0.71
CLERK 1	No.000011	00001

Keyboard PLU Entry - Single Item

Immediately after registration Single Item PLUs automatically total as a cash sale. Use single item PLUs for speedy one item sales. For example if you are selling admission tickets, and all ticket sales are one item sales, you can use an open or preset PLU. After each registration, the drawer will immediately open, and a separate transaction receipt is printed. See "**PLU Programming**" in the "**Program Mode Programming**" chapter to program a single item PLU.

1. Press a single item preset PLU. (Or enter a price and press a single item open PLU key.)

For example, press PLU 6:

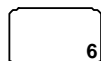

Receipt Example:

THANK-YOU		
CALL AGAIN		
DATE 15/01/2003 WED	TIME 08:33	
PLU6		\$1.29
TOTAL		\$1.29
CASH		\$1.29
CLERK 1	No.000011	00001

Code PLU Entry - Open Price

If the PRESET status of a PLU is set to N (no), the PLU will operate as an open price PLU. See "**PLU Programming**" in the "**Program Mode Programming**" chapter to program PLU descriptors and options.

1. Enter the PLU number; press the **PLU** key.

For example, enter:



2. Enter an amount on the number pad. **Do not use the decimal key.**

For example, for \$2.99, enter:

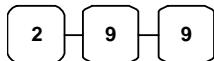

3. Press the **PLU** key again.



Receipt Example:

THANK-YOU CALL AGAIN		
DATE 15/01/2003 WED	TIME 08:33	
PLU2 T1		\$2.99
GST		\$0.18
TOTAL		\$3.17
CASH		\$3.17
CLERK 1	No.000011	00001

Code PLU Entry - Preset Price / Single Item

1. Enter the PLU number; press the **PLU** key.

For example, enter:



Receipt Example:

THANK-YOU CALL AGAIN		
DATE 15/01/2003 WED	TIME 08:33	
PLU1		\$1.29
TOTAL		\$1.29
CASH		\$1.29
CLERK 1	No.000011	00001

Code PLU Entry - Preset Price Override

If the OVERRIDE PRESET is set to Y (yes), the PLU is operating as a preset override PLU. See "PLU Programming" in the "Program Mode Programming" chapter to program PLU descriptors and options.

1. Enter the quantity of items being purchased, and then press the **X/TIME** key, even there is only one item.

For example, enter **1** on the numeric key pad and press the **X/TIME** key:

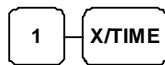

2. Enter the PLU number; press the **PLU** key.

For example, enter:



3. Enter an amount on the number pad. *Do not use the decimal key.*

For example, for \$2.99, enter:

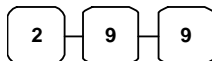

4. Press the **PLU** key again.



Receipt Example:

THANK-YOU		
CALL AGAIN		
DATE 15/01/2003 WED	TIME 08:33	
1	@\$2.99	
PLU2 T1		\$2.99
GST		\$0.18
TOTAL		\$3.17
CASH		\$3.17
CLERK 1	No.000011	00001

Code PLU Entry - Repeat

Open or preset price PLUs can be repeated as many times as necessary by pressing PLU function key again. The number of times the item is repeated is shown on the display.

1. Enter the PLU number; press the **PLU** key.

For example, enter:



2. To register a second item exactly as the first, press the **PLU** key again.



Receipt Example:

THANK-YOU		
CALL AGAIN		
DATE 15/01/2003 WED	TIME 08:33	
PLU1 T1		\$2.99
PLU1 T1		\$2.99
GST		\$0.36
TOTAL		\$6.34
CASH		\$6.34
CLERK 1	No.000011	00001

Code PLU Entry - Multiplication

When several of the same items are to be entered into the same PLU, you can use multiplication. You can enter a quantity (1 to 999.999) using the **X/TIME** key. You can multiply open or preset PLUs.

1. Enter the quantity of items being purchased, and then press the **X/TIME** key.

For example, enter **4** on the numeric key pad and press the **X/TIME** key:

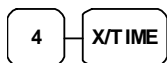

2. Enter the PLU number; press the **PLU** key.

For example, enter:



Receipt Example:

THANK-YOU		
CALL AGAIN		
DATE 15/01/2003 WED	TIME 08:33	
4X	@1.99	
PLU1 T1		\$7.96
GST		\$0.48
TOTAL		\$8.44
CASH		\$8.44
CLERK 1	No.000011	00001

Code PLU Entry - Multiplication with Decimal Point

If you are selling items by weight or by length etc., you can multiply a fraction of a unit. It is up to 3 digits after decimal places.

1. Enter the quantity with the decimal point, and then press the **X/TIME** key.

For example, for 3.75 kilos of produce, enter:

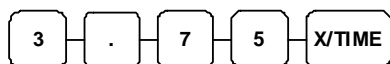

2. Enter the PLU number; press the **PLU** key.

For example, enter:



Receipt Example:

THANK-YOU		
CALL AGAIN		
DATE 15/01/2003 WED	TIME 08:33	
3.75X	@2.99	
PLU3 T1		\$11.21
GST		\$0.67
TOTAL		\$11.88
CASH		\$11.88
CLERK 1	No.000011	00001

Code PLU Entry - Split Pricing

When items are priced in groups, i.e. 3 for \$1.00, you can enter the quantity purchased and let the register calculate the correct price.

1. Enter the quantity purchased, and then press the **X/TIME** key.

For example, enter:

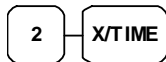

2. Enter the quantity of the group price, and then press the **X/TIME** key.

For example, if the items are priced 3 for \$1.00, enter:

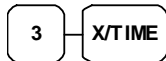

3. Enter the PLU number; press the **PLU** key.

For example, enter:



Receipt Example:

THANK-YOU		
CALL AGAIN		
DATE 15/01/2003 WED	TIME	08:33
2@3FOR	@2.99	
PLU3 T1		\$1.99
GST		\$0.12
TOTAL		\$2.11
CASH		\$2.11
CLERK 1	No.000011	00001

Barcode PLU Entry - Open Price, Single Item

1. Press 1 on the number pad, and then press the **X/TIME** key.

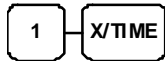

2. Scan barcode of the item.
3. Enter an amount on the number pad. *Do not use the decimal key.*

For example, for \$2.99, enter:

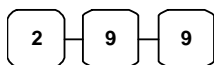

4. Press the **PLU** key.



Receipt Example:

THANK-YOU		
CALL AGAIN		
DATE 15/01/2003 WED	TIME 08:33	
1	@ \$ 2.99	
#1234567890123 T1		\$2.99
GST		\$0.18
TOTAL		\$3.17
CASH		\$3.17
CLERK 1	No.000011	00001

Barcode PLU Entry - Open Price, Multiple Items

1. Press number of items on the number pad, and then press the **X/TIME** key.

For example, for 4 identical items, enter:

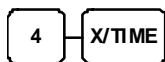

2. Scan barcode of the item.
3. Enter an amount on the number pad. *Do not use the decimal key.*

For example, for \$2.99, enter:

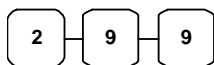

4. Press the **PLU** key.



Receipt Example:

THANK-YOU		
CALL AGAIN		
DATE 15/01/2003 WED	TIME 08:33	
4	@ \$ 2.99	
#1234567890123 T1		\$11.96
GST		\$0.72
TOTAL		\$12.68
CASH		\$12.68
CLERK 1	No.000011	00001

Barcode PLU Entry - Preset Price Override, Single Item

1. Press 1 on the number pad, and then press the **X/TIME** key.

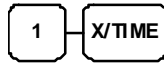

2. Scan barcode of the item.
3. Enter an amount on the number pad. *Do not use the decimal key.*

For example, for \$2.99, enter:

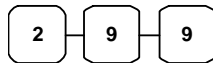

4. Press the **PLU** key.



Receipt Example:

THANK-YOU		
CALL AGAIN		
DATE 15/01/2003 WED	TIME 08:33	
1	@ \$ 2.99	
#3210987654321 T1		\$2.99
GST		\$0.18
TOTAL		\$3.17
CASH		\$3.17
CLERK 1	No.000011	00001

Barcode PLU Entry - Preset Price Override, Multiple Items

1. Press 1 on the number pad, and then press the **X/TIME** key.

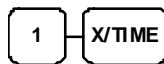

2. Scan barcode of the item.
3. Enter an amount on the number pad. *Do not use the decimal key.*

For example, for \$2.99, enter:

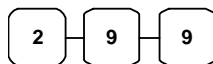

4. Press the **PLU** key.



5. For additional identical items, press more **PLU** key(s).



Receipt Example:

THANK-YOU		
CALL AGAIN		
DATE 15/01/2003 WED	TIME 08:33	
1	@ \$ 2.99	
#3210987654321 T1		\$2.99
#3210987654321 T1		\$2.99
#3210987654321 T1		\$2.99
#3210987654321 T1		\$2.99
GST		\$0.72
TOTAL		\$12.68
CASH		\$12.68
CLERK 1	No.000011	00001

Modifier Key

Pressing a modifier key alters the next PLU registered, either by changing the code number of the PLU so that a different item is registered, or by just adding the modifier descriptor and registering the same PLU. See "**Modifier 1-5**" in the "**Program Mode Programming**" chapter in order to determine how the modifier key will affect the PLU entry.

This is often used to change the size, package, pricing or even eatin/takeaway, hot/cold etc., status of PLUs. Discuss your requirements with your dealer. The PLU Report lists these items separately.

Modifiers can be:

- **Stay down** so that registrations will be modified by the same modifier until another modifier is selected,
- **Pop-up after each item** to register, for example large, medium or small soft drink,
- **Pop-up after each transaction** to register, for example, toppings of various pizza sizes.

See "**System Options**" in the "**Program Mode Programming**" chapter to select stay down/pop-up status.

Pop-Up Modifier Key Affecting PLU Code

For example: PLU 1 is DRINK for \$1.00 and PLU#1001 is DRINK for \$1.25 as large. The Modifier 1 Key descriptor is LARGE.

1. Press a preset PLU.

For example, press PLU **1** with a price of \$1.00.



2. Press the **MOD 1** key. The message "MOD1" displays.

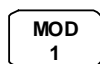

3. Press the same PLU. In this example the modifier 1 will add the digit 1 to the fourth PLU # position, resulting in the registration of PLU #1001.



4. Press another PLU. In this example press PLU **2** with a price of \$1.50.

Receipt Example:

THANK-YOU		
CALL AGAIN		
DATE	15/01/2003 WED	TIME 08:33
DRINK		\$1.00
LARGE		
DRINK		\$1.25
PLU2		\$1.50
TOTAL		\$3.75
CASH		\$3.75
CLERK 1	No.000011	00001

Price Level Key

If you choose to use the price level feature, you must allocate memory for each level. See "**Memory Allocation**" in the "**Service Mode Programming**" chapter. Note that the default program selects one price level. You must also place price level keys on the keyboard. See "**Function Key Assignment**" in the "**Program Mode Programming**" chapter.

If you use this feature, the same PLU can be given up to 2 different preset prices. Price Level keys shift the price that is being registered. Levels can be:

This feature allows you to change on item price. Often used for medium/large, eatin/takeaway, hot/cold drinks etc. The PLU Report will combine the price levels. Discuss your needs with your dealer.

- **Stay down** so that registrations will stay in the selected level until another level is selected,
- **Pop-up after each item** to register, for example large, medium or small soft drink,
- **Pop-up after each transaction** to register, for example, toppings of various pizza sizes.

See "**System Options**" in the "**Program Mode Programming**" chapter to set how the price level keys operate.

Pop-Up Price Level Keys

For example: PLU 1 is DRINK and price level 1 is \$1.00 and price level 2 is \$2.00 as large.

1. Press a preset PLU.

For example, press PLU **1** programmed with a price of \$1.00 for price level 1.

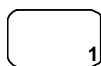

2. Press the **LEVEL 2** key. The message "LEVEL 2" displays.

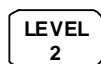

3. Press the same PLU. In this example the PLU 1 key is programmed with a price of \$2.00 for price level 2.

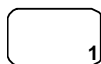

4. Press another PLU key. In this example press PLU **2** programmed to register PLU #2 with price level 1. Note that the level 1 price is registered.

Receipt Example:

THANK-YOU		
CALL AGAIN		
DATE	15/01/2003 WED	TIME 08:33
DRINK		\$1.00
DRINK		\$2.00
PLU2		\$1.50
TOTAL		\$4.50
CASH		\$4.50
CLERK 1	NO.000011	00001

Promo

The **PROMO** key allows you to account for promotional items, as in "buy two, get one free". Pressing this key will remove an item's cost from the sale, and the promo item will not be added to the PLU sales total, but it is added to the item sales counter. If stock (inventory) reporting is used, the item will be subtracted from inventory.

1. Register an item.

For example, press **PLU 1** programmed with a price of \$1.00 for price level 1.



2. Press the **PROMO** key. The message "PROMO" displays.



3. Press **PLU 1** again. You cannot enter an item that has not been already registered in this transaction.



Receipt Example:

THANK-YOU		
CALL AGAIN		
DATE 15/01/2003 WED	TIME 08:33	
PLU1		\$1.00
PROMO		
PLU1		
TOTAL		\$0.00
CASH		\$0.00
CLERK 1	No.000011	00001

Waste

The **WASTE** key allows control of inventory by accounting for items that must be removed from stock due to spoilage, breakage or mistakes. Press the **WASTE** key before entering wasted items, and then press the **WASTE** key again to finalize. The **WASTE** key may be under manager control, requiring the control lock to be in the **X** position. The **WASTE** key is not allowed within a sale.

1. Press the **WASTE** key. The message "WASTE" displays at the top of the screen.

WASTE

2. Enter the item or items that are wasted.
3. Press the **WASTE** key again to total the wasted items:

WASTE

Receipt Example:

THANK-YOU		
CALL AGAIN		
DATE 15/01/2003 WED	TIME 08:33	
WASTE		
PLU1		\$1.25
PLU2		\$1.50
WASTE		
TOTAL		\$2.75
CLERK 1	No.000011	00001

Percent Key Operations

A total of five % functions are available. %1 to %3 (for *ER-5200* and *ER-5200M*) or %1 and %2 (for *ER-5240*, *ER-5240M*, *ER-5215* and *ER-5215M*) are located on the default keyboard. Your keyboard may be different. More or less % keys may be located on the keyboard, or they may be located on one of the function look up menu keys.

Each function is individually programmable to add or subtract, from an individual item or from a sale total, amounts (coupons) or percentages. You can also program the percentage key taxable or non-taxable, so that sales taxes are calculated on the net, or the gross amount of the item or sale. You can also program preset prices or percentages.

The operation examples in this section show the percentage key in a variety of configurations. See "**Function Key Programming**" in the "**Program Mode Programming**" chapter to assign a specific function to each percentage key.

These keys will be pre-programmed to operate on EITHER **PLUs** (item) OR **SUBTOTALs** (sale), but not both; EITHER **MINUS** (discount) OR **PLUS** (surcharges), but not both; EITHER **RATE** (percentage) OR **AMOUNT** (Dollar), but not both.

So, if you want to discount items but not every item in a sale, you will need two % keys. To discount on the whole sale, you will need to press **SUBTOTAL** first.

Preset Percent Discount on an Item

In this example the %1 function is programmed with **Percentage, Negative, Item, Preset** and **Overridable** with a **rate of 10%**. Please refer to **% (1 ~ 5) (Discounts or Surcharges)** in **Function Key Programming in Program Mode Programming** for more detail.

1. Register the item.
2. Press the %1 key:

% 1
3. The discount is automatically subtracted.

Receipt Example:

THANK-YOU CALL AGAIN		
DATE 15/01/2003 WED	TIME 08:33	
PLU2		\$10.00
% 1		-10.000%
AMOUNT		-1.00
TOTAL		\$9.00
CASH		\$9.00
CLERK 1	No.000011	00001

Enter a Percent Discount on an Item

You can also operate the percentage functions by entering the percentage of the discount or surcharge. You can enter a fractional percentage up two 3 digits beyond the decimal (i.e. 99.999%) if necessary.

1. Register the discounted item.
2. Enter the percentage. If you are entering a fraction of a percent, you must use the decimal key.

For example, for one third off enter:

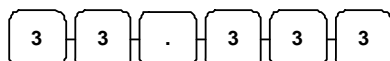

3. Press the %1 key:



4. The discount is automatically subtracted.

Receipt Example:

THANK-YOU CALL AGAIN		
DATE 15/01/2003 WED	TIME 08:33	
PLU2		\$10.00
% 1		-33.333%
AMOUNT		-3.33
TOTAL		\$6.67
CASH		\$6.67
CLERK 1	No.000011	00001

Preset Percent Discount on Sale Total

In this example the %1 function is programmed with **Percentage, Negative, Sale, Preset and Overridable** with a rate of 10%. Please refer to **% (1 ~ 5) (Discounts or Surcharges)** in **Function Key Programming in Program Mode Programming** for more detail.

1. Register the items you wish to sell.

2. Press the **SBTL** key:



3. Press the **%1** key:



4. The surcharge is automatically added.

Receipt Example:

THANK-YOU	
CALL AGAIN	
DATE 15/01/2003 WED	TIME 08:33
PLU2	\$10.00
% 1	15.000%
AMOUNT	\$1.50
TOTAL	\$11.50
CASH	\$11.50
CLERK 1	No.000011 00001

Enter a Percent Discount on Sale Total

You can also operate the percentage functions by entering the percentage of the discount or surcharge. You can enter a fractional percentage up to 3 digits beyond the decimal (i.e. 99.999%) if necessary.

1. Register the items you wish to sell.

2. Press the **SBTL** key:



3. Enter the percentage, and then press the appropriate discount key.

For example, for 15% enter:

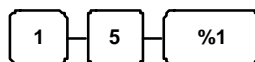

4. The surcharge is automatically added.

Receipt Example:

THANK-YOU	
CALL AGAIN	
DATE 15/01/2003 WED	TIME 08:33
PLU2	\$10.00
% 1	15.000%
AMOUNT	\$1.50
TOTAL	\$11.50
CASH	\$11.50
CLERK 1	No.000011 00001

For Surcharge Operation

When a % function is preset with “Percentage, **Positive**, Item, Preset and Overridable” or “Percentage, **Positive**, Sale, Preset and Overridable” with a preset percentage rate, the % function key will perform as a **Surcharge** on Item or Sale. Of course a override rate can be put in manually. Please refer to operation sequences on previous.

For setting, please refer to **% (1 ~ 5) (Discounts or Surcharges)** in **Function Key Programming in Program Mode Programming** for more detail.

Dollar Amount Discount on Sale

When programmed as "amount", "sale", "open" and "negative", a % key will deduct an amount from a sale. Also, depending upon programming:

- You may be allowed to enter only one discount in a sale, after the **SBTL** key is pressed,
- You may be allowed to enter multiple discounts, but you must press the **SBTL** key before each discount entry, or
- You may be allowed to enter multiple discounts, without first pressing **SBTL**.

In this example, a discount may be entered only once, and you must first press **SBTL**.

1. Register the items you wish to sell.
2. Press the **SBTL** key:



3. Enter the amount of the discount, and then press the appropriate % key.

For example:

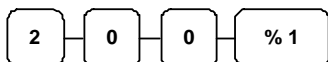

4. The discount is subtracted.

Receipt Example:

THANK-YOU		
CALL AGAIN		
DATE 15/01/2003 WED	TIME 08:33	
PLU2		\$10.00
% 1		-2.00
TOTAL		\$8.00
CASH		\$8.00
CLERK 1	No.000011	00001

Dollar Amount Discount on Item

When programmed as "amount", "item", "open" and "negative", a % key will reduce a discount amount against an item. In this case, you must press the PLU (or enter the PLU number) of the PLU you wish the discount to be subtracted from.

1. Register the items you wish to sell.
2. Enter the amount of the discount, and then press the appropriate % key.

For example:

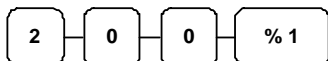

3. The discount is automatically subtracted.

Receipt Example:

THANK-YOU		
CALL AGAIN		
DATE 15/01/2003 WED	TIME 08:33	
PLU1		\$10.00
% 1		-2.00
TOTAL		\$8.00
CASH		\$8.00
CLERK 1	No.000011	00001

Return Merchandise Registrations

If you wish to return or refund an item press **RETURN**, then re-enter any item. You can return merchandise as part of a sale, or you can return merchandise as a separate transaction and return cash to the customer.

1. Press **RETURN**:



2. Enter the price of the item you wish to return, and then press the PLU key where it was registered originally.

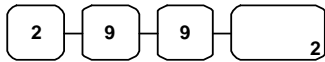

3. Total the sale with **CASH**, **CHECK**, or a **CHARGE** function.

Receipt Example:

THANK-YOU		
CALL AGAIN		
DATE 15/01/2003 WED	TIME 08:33	
RETURN *****		
PLU2 T1		-2.99
GST AMT		-0.18
TOTAL		-3.17
CASH		-3.17
CLERK 1	NO.000011	00001

Voids and Corrections

Error Correction (Void Last Item)

This function corrects the last item entered.

1. Register the item you wish to sell.
2. Press the **ERROR CORR** key:

**ERROR
CORR**

Receipt Example:

THANK-YOU CALL AGAIN		
DATE 15/01/2003 WED	TIME 08:33	
PLU1 T1		\$2.29
PLU2		\$1.29
ERR CORR -----		
PLU2		-1.29
GST AMT		\$0.14
TOTAL		\$2.43
CASH		\$2.43
CLERK 1	No.000011	00001

Void Previous Item

This function allows you to correct an item registered previously in a transaction.

1. Register an item. Then register a second item.
2. To correct the first item, press **VOID**:

VOID

3. Enter the price of the first item, and then press the PLU key where it was registered originally.

1 2 9

Receipt Example:

THANK-YOU CALL AGAIN		
DATE 15/01/2003 WED	TIME 08:33	
PLU2		\$1.29
PLU1 T1		\$2.29
VOID -----		
PLU2		-1.29
GST AMT		\$0.14
TOTAL		\$2.43
CASH		\$2.43
CLERK 1	No.000011	00001

Cancel

The **CANCEL** key allows you to stop any transaction. Anything registered within the transaction before the **CANCEL** key is pressed is automatically corrected. The **CANCEL** key can be inactivated through programming, see "**Function Key Programming**" in the "**Program Mode Programming**" chapter, or the key can be programmed to require manager control.

1. Register the items you wish to sell.
2. Press the **CANCEL** key



Receipt Example:

THANK-YOU		
CALL AGAIN		
DATE 15/01/2003 WED	TIME 08:33	
PLU1 T1		\$2.29
PLU2		-0.50
CANCEL *****		
CLERK 1	No.000011	00001

Void Mode Operations

You can use the **VOID** Mode to correct any complete transaction. To correct any transaction:

1. Turn the control lock to the **VOID-Mode**.
2. Enter the transaction you wish to correct exactly as it was entered originally in the **REG** Mode. You can enter discounts, voids, returns, tax exemptions or any other function.
3. All totals and counters are corrected as if the original transaction did not take place.

THANK-YOU		
CALL AGAIN		
DATE 15/01/2003 WED	TIME 08:33	
VOID MODE *****		
PLU1 T1		-2.29
PLU2		-1.00
GST AMT		-0.14
TOTAL		-3.43
CASH		-3.43
CLERK 1	No.000011	00001

NB. Be sure to turn the key back when finished.

No Sale Operations

Open Drawer

The **#/NO SALE** key will open the cash drawer when you have not already started a transaction. The no sale function can be disabled or placed under manager control through programming, see "**Function Key Programming**" in the "**Program Mode Programming**" chapter.

1. Press **#/NS**:



2. The drawer will open and the receipt will print as in the example on the right.

Receipt Example:

THANK-YOU		
CALL AGAIN		
DATE 15/01/2003 WED	TIME 08:33	
NO SALE -----		
CLERK 1	NO.000011	00001

Non Add Number

You can also use the **#/NO SALE** key to print any number (up to 9 digits) on the printer paper. You can enter the number any time during a transaction. For example, if you wish to record a checking account number, enter the number and press the **#/NO SALE** key before totaling the sale with the **CHECK** key.

1. Register the items you wish to sell.
2. Enter the number you wish to record.

For example enter:

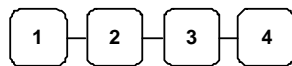

3. Press **#/NS**:



4. Press **CHECK**:

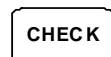

Receipt Example:

THANK-YOU		
CALL AGAIN		
DATE 15/01/2003 WED	TIME 08:33	
PLU1 T1		\$2.99
NON-ADD#	1234	
GST AMT		\$0.18
TOTAL		\$3.17
CHECK		\$3.17
CLERK 1	NO.000011	00001

Received On Account Operations

You can use one of the received on account functions (**RA1-RA3**) to accept cash or checks into the cash drawer when you are not actually selling merchandise. For example, use received on account to accept payments for previously sold merchandise or record loans to the cash drawer.

1. Press one of the received on account keys (**RA1-RA3**)

RA1

2. Enter the amount of cash received, press **CASH**.

1 0 0 0 CASH

3. Enter the check amount received, and press **CHECK**.

1 0 0 0 CHECK

4. Enter the charge amount received, press **CHARGE1**

1 0 0 0 CHARGE
1

5. You can continue to itemize receipts, or you can finalize by pressing or selecting the same received on account key.

RA1

Receipt Example:

THANK-YOU		
CALL AGAIN		
DATE 15/01/2003 WED	TIME 08:33	
RA1		
CASH		\$10.00
CHECK		\$10.00
CHARGE1		\$10.00
RA1		\$30.00
CLERK 1	No.000011	00001

Paid Out Operations

You can use the paid out function (**PO1-PO3**) to track cash or checks paid out or to record loans from the cash drawer.

1. Press one of the paid out keys (**PO1-PO3**)



2. Enter the amount of cash paid out, press **CASH**.

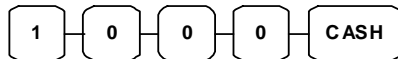

3. Enter the check amount paid out, and press **CHECK**.

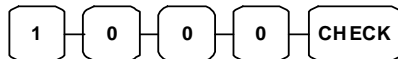

4. Enter the charge amount received, press **CHARGE1**

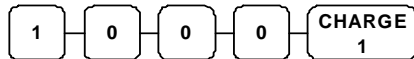

5. You can continue to itemize paid outs, or you can finalize by pressing or selecting the same paid out key.



Receipt Example:

THANK-YOU		
CALL AGAIN		
DATE 15/01/2003 WED	TIME 08:33	
PO1		
CASH		-10.00
CHECK		-10.00
CHARGE1		-10.00
PO1		-30.00
CLERK 1	No.000011	00001

Subtotaling a Sale

1. Register the items you wish to sell.
2. Press **SBTL**. The subtotal will display with the message "Sub" indicated on the rear display.



The subtotal can be printed if the system option is set. See "**Print Option Programming**" in the "**Program Mode Programming**" chapter.

Eat In/Take Out/Drive Thru Sales

Different types of sales, such as "Eat In", "Take Out" and "Drive Thru" can be categorized by placing separate keys on the keyboard. **EAT IN**, **TAKE OUT**, and **DRIVE THRU** keys function as subtotal keys. You can force the operator to press one of the keys before tendering. See "System Option Programming" in the "Program Mode Programming" chapter. Separate totals will be maintained on the financial report to detail sales counts and amounts for each key.

These keys will also print the description at the top of a KP docket.

Totaling and Tendering

There are ten tender functions available to categorize sales. **CASH** and **CHECK** are individual keys on the keyboard

Totaling a Cash Sale

1. Register the items you wish to sell.
2. To total a cash sale, press **CASH**:

CASH

3. The display will indicate the total amount of the cash sale.

Receipt Example:

THANK-YOU		
CALL AGAIN		
DATE 15/01/2003 WED	TIME 08:33	
PLU2		\$7.96
TOTAL		\$7.96
CASH		\$7.96
CLERK 1	No.000011	00001

Totaling a Check Sale

1. Register the items you wish to sell.
2. To total a cash sale, press **CHECK**:

CHECK

3. The display will indicate the total amount of the cash sale.

Receipt Example:

THANK-YOU		
CALL AGAIN		
DATE 15/01/2003 WED	TIME 08:33	
PLU2		\$7.96
TOTAL		\$7.96
CHECK		\$7.96
CLERK 1	No.000011	00001

Tendering a Cash Sale

1. Register the items you wish to sell.
2. Enter the amount tendered by the customer.

For example, for \$20.00 enter:

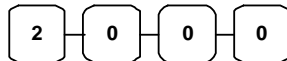

3. Press **CASH**:

4. The display will indicate the total amount of the cash tendered and the change due, if any.

Receipt Example:

THANK-YOU		
CALL AGAIN		
DATE	15/01/2003 WED	TIME 08:33
PLU1	T1	\$2.99
PLU1	T1	\$2.99
4X	\$1.99	
PLU2		\$7.96
GST		\$0.36
TOTAL		\$14.30
CASH		\$20.00
CHANGE		\$5.70
CLERK 1	NO.000011	00001

Tendering a Check Sale

1. Register the items you wish to sell.
2. Enter the amount tendered by the customer.

For example, for \$20.00 enter:

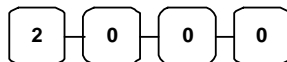

3. Press **CHECK**:

4. The display will indicate the total amount of the check tendered and the change due, if any.

Receipt Example:

THANK-YOU		
CALL AGAIN		
DATE	15/01/2003 WED	TIME 08:33
PLU1	T1	\$2.99
PLU1	T1	\$2.99
4X	\$1.99	
PLU2		\$7.96
GST		\$0.36
TOTAL		\$14.30
CHECK		\$20.00
CHANGE		\$5.70
CLERK 1	NO.000011	00001

Totaling a Charge (EFTPOS) Sale

Use the charge keys to track charge or credit card sales. See **"Function Key Programming"** in the **"Program Mode Programming"** chapter to change the descriptors for the charge tender functions. For example, you can use CHARGE 1 to track Visa card sales. The descriptor "VISA" will display on the function look up menu and print on the printer. You can also set tendering options for the charge keys, i.e. whether to allow over tendering or to enforce tendering.

1. Register the items you wish to sell.
2. Press one of the charge key if it is located on the keyboard:

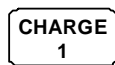

Receipt Example:

THANK-YOU CALL AGAIN		
DATE 15/01/2003 WED	TIME 08:33	
PLU1 T1		\$2.99
PLU1 T1		\$2.99
4X	\$1.99	
PLU2		\$7.96
GST		\$0.36
TOTAL		\$14.30
CHARGE1		\$14.30
CLERK 1	No.000011	00001

Tendering a Charge (EFTPOS) Sale

Tendering a charge sale may or may not be allowed. See **"Function Key Programming"** in the **"Program Mode Programming"** chapter to set tendering options for the charge keys, i.e. whether to allow over tendering or to enforce tendering.

1. Register the items you wish to sell.
2. Enter the amount of the charge and press one of the charge keys if it is located on the keyboard:

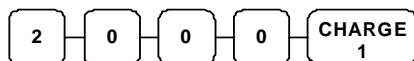

Receipt Example:

THANK-YOU CALL AGAIN		
DATE 15/01/2003 WED	TIME 08:33	
PLU1 T1		\$2.99
PLU1 T1		\$2.99
4X	\$1.99	
PLU2		\$7.96
GST		\$0.36
TOTAL		\$14.30
CHARGE1		\$20.00
CHANGE		\$5.70
CLERK 1	No.000011	00001

Cash Out within a Charge (EFTPOS) Sale

CASH OUT within a charge (EFTPOS) sale may or may not be allowed. See "**Function Key Assignment Programming**" in the "**Service Mode Programming**" chapter to assign **CASH OUT** key.

1. Register the items you wish to sell.
2. Enter the amount of cash for cash out then press **CASH OUT** key.

2 0 0 0 CASH OUT

3. Press **EFTPOS** key.

EFTPOS

Receipt Example:

THANK-YOU		
CALL AGAIN		
DATE 15/01/2003 WED	TIME	08:33
PLU1 T1		\$2.99
PLU1 T1		\$2.99
4X	\$1.99	
PLU2		\$7.96
GST		\$0.36
SUBTOTAL		\$14.30
CASH OUT		\$20.00
EFTPOS		\$34.30
CHANGE		\$20.00
CLERK 1	No.000011	00001

Check Cashing

Check cashing means exchanging cash for a check. If you wish to cash checks, you must place a **CHKCASH** key on the keyboard. See "**Function Key Assignment**" in the "**Program Mode Programming**" chapter.

1. Enter the amount of the check tendered by the customer.

For example, for \$20.00 enter:



2. Press **CHKCASH**:

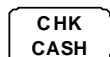

3. The display will indicate the amount of the check and the cash change.

Receipt Example:

THANK-YOU	
CALL AGAIN	
DATE 15/01/2003 WED	TIME 08:33
CHKCASH	
CHECK	\$20.00
CASH	-20.00
CLERK 1	No.000011 00001

Split Tender

Split tendering is paying for one transaction by more than one payment method. For example, a \$20.00 sale could be split so \$10.00 is paid in cash, and the remaining \$10.00 is paid by a check. If necessary, you can make several different payments.

1. Register the items you wish to sell.
2. Enter the amount of cash tendered by the customer.

For example, enter \$10.00 and press **CASH**:

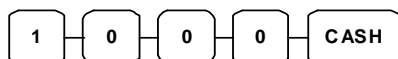

3. The display will indicate the \$10.00 cash tender and the \$10.00 total still due.
4. Enter the amount of check tendered by the customer.

For example, enter \$10.00 and press **CHECK**:

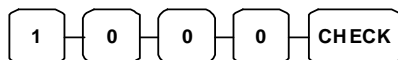

5. When the total tendered equals or exceeds the total due, the receipt will print and the transaction is complete.

Receipt Example:

THANK-YOU	
CALL AGAIN	
DATE 15/01/2003 WED	TIME 08:33
PLU2	\$20.00
TOTAL	\$20.00
CASH	\$10.00
TOTAL	\$10.00
CHECK	\$10.00
CLERK 1	No.000011 00001

Post Tender

Post tendering means computing change after the sale has been totaled and the drawer is open. This feature is useful when a customer changes the amount of the tender or when a "quick change artist" confuses a clerk. Normally, this function is not allowed. If you wish to allow post tendering, you must set the appropriate system option.

1. Register the items you wish to sell.

2. Press **CASH**:



3. The display will indicate the total of the cash sale.

4. Enter the amount of the new tender, Press **CASH**:

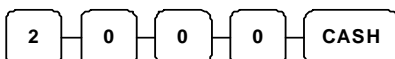

5. The display will indicate the change due.

Receipt Example:

THANK-YOU		
CALL AGAIN		
DATE 15/01/2003 WED	TIME 08:33	
PLU1 T1		\$2.00
GST		\$0.12
CASH		\$2.12
CLERK 1	No.000011	00001

Currency Conversion

If you normally accept currency from neighboring nations, you can program to convert the subtotal of a sale to the equivalent cost in the foreign currency. You can set up four separate conversion functions for different foreign currencies. To do this, you need to program the conversion factor. For example, if the US dollar (home currency) is worth 1.3720 Canadian dollars (foreign currency), the conversion factor is 1.3720. See "Function Key Programming" in the "Program Mode Programming" chapter to set a conversion factor.

1. Register the items you wish to sell.

2. Press the **CONV1** key if it is located on the keyboard:



3. Enter the amount of the foreign currency tender, Press **CASH**:

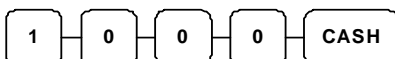

4. The display will indicate the amount of foreign currency tendered and display \$5.17 change due. **The change due is computed in home currency!**

Receipt Example:

THANK-YOU		
CALL AGAIN		
DATE 15/01/2003 WED	TIME 08:33	
PLU1 T1		\$2.00
GST		\$0.12
TOTAL		\$2.12
CONV 1		¥2.90
CHANGE RATE	@1.3720	
HOME AMT.		\$10.00
CHANGE		\$5.17
CLERK 1	No.000011	00001

The currency symbol you program will display here. See "**Print Option Programming**" in the "**Program Mode Programming**" chapter.

Table Management and Clerk Interrupt Operations

Overview

The *ER-5200/ER-5200M Series* can employ a manual previous balance, hard check (**Monthly Accounts**), or soft check (**Restaurant Bill**) system. (You must select hard or soft check posting in **Memory Allocation Programming** - the default selection is soft.)

There are two methods in *ER-5200/ER-5200M Series* to manage check track. One is table management system and the other is clerk interrupt system. If you want to use clerk interrupt system.

First, Program as below.

To Enter Clerk Interrupt System (To Exit Table Management system)

1. Program Clerk Secret Code.

Please check **Memory Allocation** in **Service Mode** for numbers of Clerks in the system. Also see "**Secret Code Programming**" to program Clerk Secret Code.

2. Set system option #2 to a value of **1**. See "**System Option Programming**".
3. Set system option #26 to a value of **1**. See "**System Option Programming**".

To Exit Clerk Interrupt System (To Enter Table Management system)

1. Set system option #26 to a value of **0**. See "**System Option Programming**".
2. Set system option #2 to a value of **0**. See "**System Option Programming**".

Soft Check - Restaurant Style Billing

Opening a Soft Check

1. Enter the number of the guest check, press the **CHECK #** key:

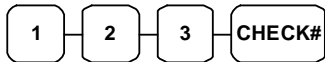

or, press the **CHECK #** key to automatically assign a check:



2. If required, enter the table number and press the **TABLE** key:



3. If required, enter the number of guests and press the **GUEST** key:

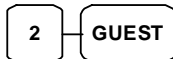

4. Register the items you wish to sell.
5. To total the posting, press **SERVICE**:



Receipt Example:

THANK-YOU CALL AGAIN		
DATE 15/01/2003 WED	TIME 08:33	
CHECK #		#123
PBAL		\$0.00
TABLE		#3
GUEST		#2
CHICKEN		\$7.00
STEAK		\$10.00
SERVICE		\$17.00
BFWD		\$17.00
CLERK 1	No.000011	00001

NOTE: If a table number entry is required for all guest checks, and checks are assigned by register, the check will be assigned by the register when the table # is entered.

Adding to a Soft Check

1. Enter the number of the guest check, press the **CHECK #** key:

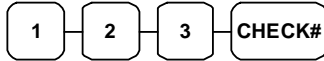

or, if you entered a table number, enter the table number and press the **TABLE** key:



2. Register the next items you wish to sell.
3. To total the posting, press **SERVICE**:



Printing a Soft Check

1. Enter the number of the guest check, press the **CHECK #** key:

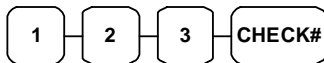

or, if you entered a table number, enter the table number and press the **TABLE** key:



2. Press **PRINT CHECK** to print the complete check. If programmed to do so, the **PRINT CHECK** key will automatically service the check:



Receipt Example:

THANK-YOU		
CALL AGAIN		
DATE 15/01/2003 WED	TIME 08:33	
CHECK #	#123	
PBAL	\$17.00	
TABLE	#3	
GARLIC BREAD	\$2.00	
SERVICE	\$2.00	
BFWD	\$19.00	
CLERK 1	No.000012	00001

Receipt Example:

THANK-YOU		
CALL AGAIN		
DATE 15/01/2003 WED	TIME 08:33	
CHECK #	#123	
PBAL	\$19.00	
TABLE	#3	
CHICKEN	\$7.00	
STEAK	\$10.00	
GARLIC BREAD	\$2.00	
SERVICE	\$0.00	
BFWD	\$19.00	
	CHK # :	1
CLERK 1	No.000012	00001

The number of times each check has been printed is counted and printed on the check

Paying a Soft Check without Payment Key required to Close Check

1. Enter the number of the guest check, press the **CHECK #** key:

1 2 3 CHECK#

or, if you entered a table number, enter the table number and press the **TABLE** key:

3 TABLE

2. If necessary, add additional items. If you wish to add a tip, press **SBTL**, then enter the tip amount and press the **TIP** key:

SBTL

3 0 0 TIP

3. Pay the balance, as you would normally tender a transaction, with **CASH**, **CHECK**, or one of the **CHARGE** keys. If the tender is greater than the balance due, change is displayed.

2 5 0 0 CASH

Receipt Example:

THANK-YOU	
CALL AGAIN	
DATE 15/01/2003 WED	TIME 08:33
CHECK #	#123
PBAL	\$19.00
TABLE	#3
TIP	\$3.00
CHECKS PAID	\$22.00
CASH	\$25.00
CHANGE	\$3.00
	CHK # : 2
CLERK 1	No.000013 00001

Taking Deposits or Account Payments with Payment Key required to Close Check

Taking Deposits or Account Payments, can only be done when the Payment key is programmed as “**Required to Close Check=YES**”. See “**Function Key Programming - Payment**” in “**Program Mode Programming**”.

1. Enter the number of the guest check, press the **CHECK #** key:

1 — 2 — 3 — CHECK#

or, if you entered a table number, enter the table number and press the **TABLE** key:

3 — TABLE

2. To enter a Deposit or Account payment, simply enter the amount given and press the tender type followed by the **SERVICE** key:

1 — 5 — 0 — 0 — CASH

SERVICE

Receipt Example:

THANK-YOU	
CALL AGAIN	
DATE 15/01/2003 WED	TIME 08:33
CHECK #	#123
PBAL	\$19.00
TABLE	#3
CASH	\$15.00
BFW	\$4.00
	CHK # : 2
CLERK 1	No.000013 00001

Paying a Soft Check with Payment Key required to Close Check

Taking Deposits or Account Payments, can only be done when the Payment key is programmed as “Required to Close Check=YES”. See “Function Key Programming - Payment” in “Program Mode Programming”.

1. Enter the number of the guest check, press the **CHECK #** key:

1 2 3 CHECK#

or, if you entered a table number, enter the table number and press the **TABLE** key:

3 TABLE

2. If necessary, add additional items. If you wish to add a tip, press **SBTL**, then enter the tip amount and press the **TIP** key:

SBTL

3 0 0 TIP

3. Press the **PAYMENT** key then enter amount tendered as you would normally tender a transaction, with **CASH**, **CHECK**, or one of the **CHARGE** keys. If the tender is greater than the balance due, change is displayed.

PAYMENT

7 0 0 CASH

Receipt Example:

THANK-YOU	
CALL AGAIN	
DATE 15/01/2003 WED	TIME 08:33
CHECK #	#123
PBAL	\$4.00
TABLE	#3
TIP	\$3.00
CHECKS PAID	\$22.00
CASH	\$7.00
CHANGE	\$3.00
	CHK # : 2
CLERK 1	No.000013 00001

Hard Check - Monthly Account Style Billing

Opening a Hard Check

1. Enter the number of the guest check, press the **CHECK #** key:

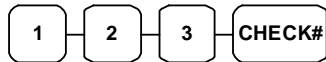

or, press the **CHECK #** key to automatically assign a check:



2. Register the items you wish to sell.
3. Place a slip in an optional slip printer, the check will print automatically when you press **SERVICE**:



Receipt Example:

THANK-YOU CALL AGAIN		
DATE 15/01/2003 WED	TIME 08:33	
CHECK #	#123	
PBAL	\$0.00	
CHICKEN	\$7.00	
STEAK	\$10.00	
SERVICE	\$17.00	
BFWD	\$17.00	
CLERK 1	NO.000011	00001

NOTE: If a table number entry is required for all guest checks, and checks are assigned by register, the check will be assigned by the register when the table # is entered.

Adding to a Hard Check

1. Enter the number of the guest check, press the **CHECK #** key:

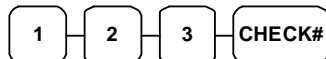

2. Register the next items you wish to sell.
3. To total the posting, press **SERVICE**:



Receipt Example:

THANK-YOU CALL AGAIN		
DATE 15/01/2003 WED	TIME 08:33	
CHECK #	#123	
PBAL	\$17.00	
GARLIC BREAD	\$2.00	
SERVICE	\$2.00	
BFWD	\$19.00	
CLERK 1	NO.000012	00001

Paying a Hard Check without Payment Key required to Close Check

1. Enter the number of the guest check, press the **CHECK #** key:

1 2 3 CHECK#

2. Pay the balance, as you would normally tender a transaction, with **CASH**, **CHECK**, or one of the **CHARGE** keys. If the tender is greater than the balance due, change is displayed.

2 5 0 0 CASH

Receipt Example:

THANK-YOU	
CALL AGAIN	
DATE 15/01/2003 WED	TIME 08:33
CHECK #	#123
PBAL	\$19.00
CHECKS PAID	\$22.00
CASH	\$25.00
CHANGE	\$3.00
	CHK # : 2
CLERK 1	No.000013 00001

Taking Deposits or Account Payments with Payment Key required to Close Check

Taking Deposits or Account Payments, can only be done when the Payment key is programmed as “Required to Close Check=YES”. See “Function Key Programming - Payment” in “Program Mode Programming”.

1. Enter the number of the guest check, press the **CHECK #** key:

1 2 3 CHECK#

2. Enter the amount given and press the tender type followed by the **SERVICE** key.

1 5 0 0 CASH

SERVICE

Receipt Example:

THANK-YOU	
CALL AGAIN	
DATE 15/01/2003 WED	TIME 08:33
CHECK #	#123
PBAL	\$19.00
CASH	\$15.00
BFW	\$4.00
	CHK # : 2
CLERK 1	No.000013 00001

Paying a Hard Check with Payment Key required to Close Check

Taking Deposits or Account Payments, can only be done when the Payment key is programmed as “**Required to Close Check=YES**”. See “**Function Key Programming - Payment**” in “**Program Mode Programming**”.

1. Enter the number of the guest check, press the **CHECK #** key:

1 2 3 CHECK#

2. Press the **PAYMENT** key then enter amount tendered as you would normally tender a transaction, with **CASH**, **CHECK**, or one of the **CHARGE** functions. If the tender is greater than the balance due, change is displayed.

PAYMENT

7 0 0 CASH

Receipt Example:

THANK-YOU		
CALL AGAIN		
DATE 15/01/2003 WED	TIME 08:33	
CHECK #	#123	
PBAL	\$4.00	
CHECKS PAID	\$22.00	
CASH	\$7.00	
CHANGE	\$3.00	
	CHK # :	2
CLERK 1	No.000013	00001

Sample of Hard Check postings printed on an optional CBM-820 printer

Example **without** Payment Key Required to Close Check:

DATE	15/01/2003	WED
CHECK #	#123	
PBAL	\$0.00	
CHICKEN	\$7.00	
STEAK	\$10.00	
SERVICE	\$17.00	
BFWD	#17.00	
No.000011 REG 01 CLERK 1	TIME 08:33	
DATE	15/01/2003	WED
CHECK #	#123	
PBAL	\$17.00	
GARLIC BREAD	\$2.00	
SERVICE	\$2.00	
BFWD	#19.00	
No.000012 REG 01 CLERK 1	TIME 08:33	
DATE	15/01/2003	WED
CHECK #	#123	
PBAL	\$19.00	
CHECKS PAID	\$22.00	
CASH	\$25.00	
CHANGE	\$3.00	
No.000013 REG 01 CLERK 1	TIME 08:33	

Example **with** Payment Key Required to Close Check (**Allows Part Payment**):

DATE	15/01/2003	WED
CHECK #	#123	
PBAL	\$0.00	
CHICKEN	\$7.00	
STEAK	\$10.00	
SERVICE	\$17.00	
BFWD	#17.00	
No.000011 REG 01 CLERK 1	TIME 08:33	
DATE	15/01/2003	WED
CHECK #	#123	
PBAL	\$17.00	
GARLIC BREAD	\$2.00	
SERVICE	\$2.00	
BFWD	#19.00	
No.000012 REG 01 CLERK 1	TIME 08:33	
DATE	15/01/2003	WED
CHECK #	#123	
PBAL	\$19.00	
CASH	\$15.00	
SERVICE	\$0.00	
BFWD	#4.00	
No.000013 REG 01 CLERK 1	TIME 08:33	
DATE	15/01/2003	WED
CHECK #	#123	
PBAL	\$4.00	
CHECKS PAID	\$22.00	
CASH	\$25.00	
CHANGE	\$3.00	
No.000014 REG 01 CLERK 1	TIME 08:33	

NOTE: If Date is not printing on the slip, please refer to **“Print Option Programming” option #27-2 in “Program Mode Programming”**.

Scale Entry

Direct Scale Entry

Place a product on the scale and access the **SCALE** function to display the weight on the cash register. Then make the appropriate entry; the PLU must have "**scalable**" status.

1. Place an item on the scale.
2. Press the **SCALE** key.



3. Note that the weight is displayed on the screen. Enter the price per **kilo** on the number pad. *Do not use the decimal key.*

For example, for \$3.00, enter:

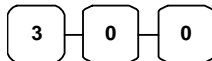

4. Press a PLU.

For example, press PLU 1:



Receipt Example:

THANK-YOU		
CALL AGAIN		
DATE 15/01/2003 WED	TIME 08:33	
1.50 kg	@3.00/kg	
PLU1		\$4.50
GST		\$0.27
TOTAL		\$4.77
CASH		\$4.77
CLERK 1	No.000011	00001

Automatic Scale Entry

Place a product on the scale and make the appropriate PLU entry. The PLU must be set with "auto scale status" & "Scalable".

1. Place an item on the scale.
2. Press a PLU key, if the item is a preset item, or enter the price per **kilo** on the number pad. *Do not use the decimal key.*

For example, for \$3.00, enter:

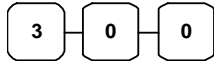

3. Press a PLU.

For example, press PLU 1:

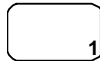

Receipt Example:

THANK-YOU CALL AGAIN		
DATE 15/01/2003 WED	TIME 08:33	
1.50 kg	@3.00/kg	
PLU1		\$4.50
GST		\$0.27
TOTAL		\$4.77
CASH		\$4.77
CLERK 1	No.000011	00001

Tare Weight Entry

1. Place an item on the scale.
2. Enter the preprogrammed tare number. Press the **TARE** key.



3. Press the **SCALE** key.

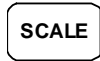

4. Note that the weight, less the tare weight, is displayed on the screen. Enter the price per kilo on the number pad. *Do not use the decimal key.*

For example, for \$3.00, enter:

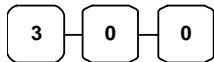

5. Press a PLU.

For example, press PLU 1:

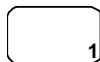

Receipt Example:

THANK-YOU CALL AGAIN		
DATE 15/01/2003 WED	TIME 08:33	
1.50 kg	@3.00/kg	
PLU1		\$4.50
GST		\$0.27
TOTAL		\$4.77
CASH		\$4.77
CLERK 1	No.000011	00001

Manual Tare Weight Entry

1. Place an item on the scale.
2. Enter the manual tare number, **5**. Press the **TARE** key:



3. Enter the weight of the tare.
For example, enter **.01**, press the tare key:

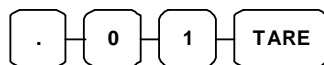

4. Press the **SCALE** key.



5. Note that the weight, less the tare weight, is displayed on the screen. Enter the price per **kilo** on the number pad. *Do not use the decimal key.*

For example, for \$3.00, enter:

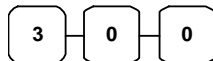

6. Press a PLU.

For example, press PLU **1**:



Receipt Example:

THANK-YOU		
CALL AGAIN		
DATE 15/01/2003 WED	TIME	08:33
1.50 kg	@3.00/kg	
PLU1		\$4.50
GST		\$0.27
TOTAL		\$4.77
CASH		\$4.77
CLERK 1	No.000011	00001

Manual Weight Entry

Operators can make manual weight entries if the item has been programmed to accept them. You must use the decimal key to enter fractional manual weights.

1. Place an item on the scale.
2. Enter the weight using the decimal key for fractional weights. Press the **SCALE** key:

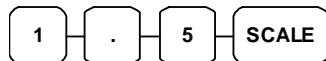

3. Enter the price per **kilo** on the number pad. *Do not use the decimal key.*

For example, for \$3.00, enter:

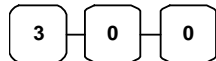

4. Press a PLU.

For example, press PLU 1:

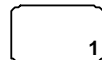

Receipt Example:

THANK-YOU		
CALL AGAIN		
DATE 15/01/2003 WED	TIME 08:33	
1.50 kg	MANUAL WT. @	@3.00
PLU1		\$4.50
GST		\$0.27
TOTAL		\$4.77
CASH		\$4.77
CLERK 1	NO.000011	00001

X/Z Mode

Introduction

All Management Functions take place with the control lock in the **X** position. In this way only those with the correct key will have access to these functions. Some register operations may be programmed to require the control lock in the **X** position in order to operate. All reports require a key that will access the **X** or **Z** position.

X/Z Reports

System reports are divided into two basic categories:

- **X** reports (include **X1** and **X2** reports) in **X** Mode, which read totals without resetting
- **Z** reports (include **Z1** and **Z2** reports) in **Z** Mode, which read totals and reset them to zero

Most reports are available in both categories. Some reports, such as the Cash-in-Drawer report and the From-To PLU report are available only as **X1** reports.

Some reports also provide identical but separate *period to date* (**X2** and **Z2**) reports. These reports maintain a separate set of totals which may be allowed to accumulate over a period of days, weeks, months, or even years. **X2** reports read period to date totals without resetting, and **Z2** reports read period to date totals and reset them to zero. Period to date report (**X2** and **Z2**) totals are updated each time a **Z1** report is completed.

When register is operating, **X1** and **Z1** reports are updated at the same time, after **Z1** reports are made, the records are forwarded and updated to **X2** and **Z2** reports at the same time, and **X1** and **Z1** reports are reset to zero. When **Z2** reports are made, the records in **X2** and **Z2** reports are reset to zero.

A complete list of available reports is presented in a chart on the following page.

An example is given for each of these reports in the pages that follow. Those reports which may be optionally abbreviated through register programming are represented twice. They are first shown with the option off, giving all totals, and again with the option turned on, showing the abbreviated version of the same report.

Registers programmed with pop-up clerks must be signed on in the **REG** control lock position prior to taking reports.

Running a Report - General Instructions

1. Refer to the "Report Table".
2. Select a report type and the report mode.
3. Turn the control lock to the position indicated.
4. Enter the key sequence for the report you have selected.

Report Table

Report Type	Report Number	Report Mode	Control Lock Position	Key Sequence
Financial	1	X1	X	1 – SBTL
		Z1	Z	1 – SBTL
		X2	X	201 – SBTL
		Z2	Z	201 – SBTL
Time	2	X1	X	2 – SBTL
		Z1	Z	2 – SBTL
		X2	X	202 – SBTL
		Z2	Z	202 – SBTL
All PLU	3	X1	X	3 – SBTL
		Z1	Z	3 – SBTL
		X2	X	203 – SBTL
		Z2	Z	203 – SBTL
All Clerk	4	X1	X	4 – SBTL
		Z1	Z	4 – SBTL
		X2	X	204 – SBTL
		Z2	Z	204 – SBTL
Group	5	X1	X	5 – SBTL
		Z1	Z	5 – SBTL
		X2	X	205 – SBTL
		Z2	Z	205 – SBTL
All STOCK	6	X1	X	6 – SBTL
		Z1	Z	6 – SBTL
Daily Sales	8	X2	X	208 – SBTL
		Z2	Z	208 – SBTL
Individual Clerk Report	9	X1	X	9-SBTL-#-CLERK-#-CLERK
		X2	X	209-SBTL-#-CLERK-#-CLERK
Open Table REPORT TABLE	11	X1	X	11 – SBTL
		Z1	Z	11 – SBTL
From/To PLU	13	X1	X	13-SBTL XXXX – PLU – XXXX – PLU
		X2	X	213-SBTL XXXX – PLU – XXXX – PLU
From/To STOCK	14	X1	X	14-SBTL XXXX –PLU – XXXX – PLU
DRAWER TOTAL	111	X1	X	111-SBTL

Reset Hard Check (Slip) Line # (EPROM v3.4R)

If you want to reset hard check line # to **0**, follow below sequence after turn control lock to **Z-Mode**.

Program 10 - Reset Hard Check Line # Programming

1. Reset **All** Hard Check Line #.



2. Reset **an Individual** Hard Check Line #.



This resets the auto line find function on the slip printer.

Cash Declaration

If compulsory cash declaration is required, you must declare the count of the cash drawer prior to taking **X** or **Z** financial and clerk reports.

You can enter the cash drawer total in one step, or to facilitate the counting of the cash drawer, you can enter each type of bill/coin and checks separately and let the register act as an adding machine. You can also use the **X/TIME** key to multiply the denomination of currency times your count.

Either way you choose to enter cash, the register will compare your declaration with the expected cash and check in drawer totals and print the over or short amounts on the report.

Program 90 - Cash Declaration Programming

For example:

1. Turn the control lock to the **X-Mode** or **Z-Mode** (depending upon the type of report you are taking.)

2. Press the **SBTL** key.

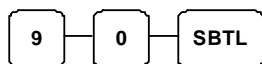

3. Enter the total of cash.

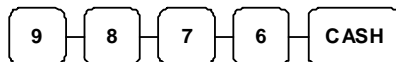

4. Enter the total of checks.

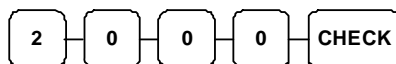

5. Press the **CASH** key to total the declaration.



DATE 15/01/2003 WED	TIME 08:33	
***	CASH DECLARATION	***
CASH		\$98.76
CHECK		\$20.00
INPUT AMT		\$118.76
DRAWER TTL		\$118.76
DIFFERENCE		\$0.00
CLERK 1	No.000001	00000

Service Mode Programming

Overview

The following procedures are done from the Service Mode menu:

- *Program 20 - Clear All Sales Totals*
- *Program 30 - Clear Grand Total*
- *Program 40 - Clear / Delete PLU File*
- *Program 50 - EPROM Information*
- *Program 60 - Memory Allocation Programming / Scan*
- *Program 70 - Function Key Assignment Programming*
- *Program 8x - RS232C Serial Ports Communication Options*

Memory Allocation Scan

1. Turn the control lock to the **S-Mode** to scan the allocated memory.
2. Enter **6 0**, press the **SBTL** key.

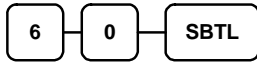

3. Press **CASH** key.



PC Online Mode

In *ER-5200/ER-5200M series*, there are no special commands to enter PC Online Mode.

When you want to enter PC Online mode, all you have to do is to set 232 Communication Option in Programming.

When PC sends commands to ECR, The ECR will be automatically Online Mode if connected.

Memory Allocation

NB. This will clear the Memory!

Program 60 - Memory Allocation Programming

1. Turn the control lock to the **S-Mode**.
2. To **Allocate Memory**, enter **6 0**, and then press the **SBTL** key.

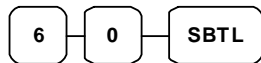

3. Refer to the chart below. Enter the index number and press the **X/TIME** key.

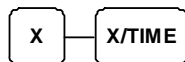

X	MEMORY ITEM
1	PLU
2	CLERK
3	GROUP
4	CHECK#
5	SOFT CHECK LINE
6	CHECK TYPE : Hard (1), Soft (0)
7	PRICE LEVEL
8	MIX AND MATCH

4. Enter the Number to allocate for the Memory Item and Press **CASH** key.
See the example data table below

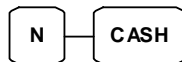

MEMORY ITEM	N
PLU	1000 (Max.15000)
CLERK	15 (Max. 99)
GROUP	20 (Max. 99)
CHECK #	15 (Max. 500)
SOFT CHECK LINE	50 (Max. 100)
CHECK TYPE	0 (Soft Check), 1(Hard Check)
PRICE LEVEL	1 (Max. 2)
MIX AND MATCH	20 (Max. 100)

※Default values have been highlighted in **bold** print

5. If you want to finish memory allocation, press **CASH** key again with no numeric key input.
If you want to allocate another memory area, repeat step 3 and 4.



Clear All Sales Totals

Program 20 - Clear All Sales Totals

1. Turn the control lock to the **S-Mode**.
2. To **Clear All Sale Totals**, enter **2 0**, and then press the **SBTL** key.

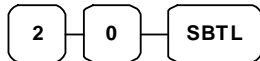

Clear Grand Total

Program 30 - Clear Grand Total

1. Turn the control lock to the **S-Mode**.
2. To **Clear Grand Total**, enter **3 0**, and then press the **SBTL** key.

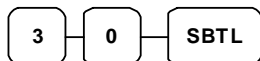

Clear / Delete PLU File

Program 40 - Clear / Delete PLU File

1. Turn the control lock to the **S-Mode**.
2. To **Clear / Delete PLU File**, enter **4 0**, and then press the **SBTL** key.

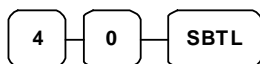

EPRM Information

Program 50 - EPRM Information

1. Turn the control lock to the **S-Mode**.
2. To **Scan EPRM Information**, enter **5 0**, and then press the **SBTL** key.

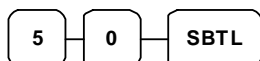

Function Key Assignment Programming

Function keys may be relocated, inactivated or changed with this program. For example, you may wish to place functions, such as **PREVIOUS BALANCE** and **SERVICE** that are not placed on the default keyboard. Or perhaps, you may wish to remove a function, such as **CANCEL**, for security reasons.

Program 70 - Function Key Assignment Programming

Please note the following limitations:

- If you assign a duplicate of a function code, the duplicate will function exactly as the original - you will not get separate totals and counters on reports for the duplicated key.
- You can reassign keys only in locations that are programmable. See “Keyboard”, where the key locations that may be programmed are identified.

To Assign a Function Key to a Location:

1. Turn the control lock to the **S-Mode**.
2. Enter **7 0**, and then press the **SBTL** key.

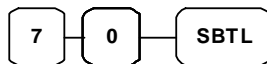

3. Refer to Function Key Codes to find the code for the key you wish to assign, press the location you wish to program. Repeat this step to assign another key.

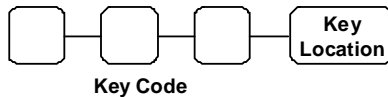

4. Press **CASH** key to finalize key assignment program.



Function Key Codes

Code	Function	Code	Function	Code	Function	Code	Function
1~	NLU 1	143	CHARGE 2	170	MACRO 1	197	SCALE
117	NLU 117	144	CHARGE 3	171	MACRO 2	198	SERVICE
118	RESERVED	145	CHARGE 4	172	MACRO 3	199	TABLE #
119	RESERVED	146	CHARGE 5	173	MACRO 4	200	TARE
120	Numeric 1	147	CHARGE 6	174	MACRO 5	201	TAKE OUT
121	Numeric 2	148	CHARGE 7	175	MACRO 6	202	TAX EXEMPT
122	Numeric 3	149	CHARGE 8	176	MACRO 7	203	TAX SHIFT 1
123	Numeric 4	150	CHECK CASHING	177	MACRO 8	204	TAX SHIFT 2
124	Numeric 5	151	ENDORSE	178	MACRO 9	205	TAX SHIFT 3
125	Numeric 6	152	CHEQUE TEND	179	MACRO 10	206	TAX SHIFT 4
126	Numeric 7	153	CHECK #	180	RETURN	207	TIP
127	Numeric 8	154	CLEAR (ESC)	181	MOD 1	208	VOID
128	Numeric 9	155	CLERK #	182	MOD 2	209	WASTE
129	Numeric 0	156	CURR. CONV. 1	183	MOD 3	210	VALIDATION
130	Numeric 00	157	CURR. CONV. 2	184	MOD 4	211	PAYMENT
131	DECIMAL	158	CURR. CONV. 3	185	MOD 5	212	RECEIPT ON/OFF
132	#/NS	159	CURR. CONV. 4	186	P/BAL	213	DETAIL FEED
133	%1	160	DRIVE THRU	187	PAID OUT 1	214	INACTIVE
134	%2	161	EAT-IN	188	PAID OUT 2	215	NON ADD
135	%3	162	ERR CORRECT	189	PAID OUT 3	216	PRICE INQUIRY (EPROM v1.0 ER-52xxM; v1.9 ER-52xx)
136	%4	163	F/S SHIFT	190	RECEIPT FEED		
137	%5	164	F/S SUB	191	PRINT CHECK		
138	XTIME	165	F/S TEND	192	PROMO	217	CASH OUT (EPROM v3.9R)
139	ADD CHECK	166	GUEST	193	REC ON ACCT 1		
140	CANCEL	167	PLU	194	REC ON ACCT 2		
141	CASH	168	LEVEL 1	195	REC ON ACCT 3		
142	CHARGE 1	169	LEVEL 2	196	SBTL		

RS232C Serial Ports Communication Options

You must define the device that is attached to the RS-232C communications port, and the options for the device. **The Default is Comm1 is set to PC Polling**

Program 8x - RS232C Serial Ports Communication Options

1. Turn the control lock to the **S-Mode**.
2. Enter **8 0** and press the **SBTL** key to Program Port 1 OR Enter **8 1** and press the **SBTL** key to Program Port 2.
3. Refer to the chart RS-232C option chart that follows and enter the number of the address you wish to program and press the **X/TIME** key.
4. Enter the value that represents your selection and press the **CASH** key.
5. Repeat from step 2 for any additional options you wish to program.
6. Press **CASH** to exit the program

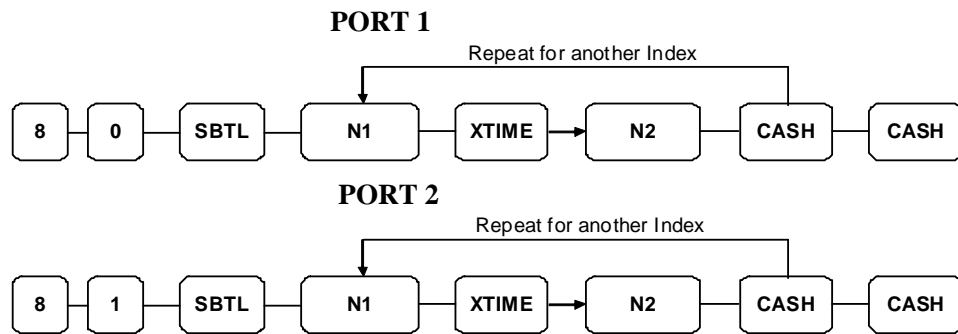

N1	OPTION	N2	VALUE
1	Baud Rate	0	9600 BPS
		1	1200 BPS
		2	2400 BPS
		3	4800 BPS
		4	19200 BPS
2	Parity	0	NONE
		1	ODD
		2	EVEN
3	Data Bits	0	8 BITS
		1	7 BITS
4	Stop Bits	0	1 BIT
		1	2 BIT

N1	OPTION	N2	VALUE
5	Device Function (Port1 is set to 1 PC as default (EPROM v1.014); Port2 is set to 0 NONE as default)	0	NONE
		1	PC
		2	SCALE
		3	RJ* / CCTV (EPROM v1.003)
		4	RECEIPT PRINTER
		6	SCANNER
		7	COIN
		8	EFT
		9	POLE
6	Initial Feeding Line KP	0 – 20	0
7	End Feeding Line KP	0 – 20	7
8	Initial Feeding Line Slip	0 – 20	0
9	Print Line On Guest Check	0 – 50 (0 – 100, modified on EPROM v5.8)	0 (Preset “0” is equivalent to 30 lines)
10	Scale Type	0	NCI
		1	CAS
11	Printer Type (SAM4S ELLIX 10, ELLIX 20 and SRP-270 are added and replace from 1 to 3 in EPROM v2.0-ER-52.xxM; EPROM v2.9-ER-52.xx)	0	NONE
		1	SAM4S ELLIX 10 SAMSUNG SRP-100
		2	SAM4S ELLIX 20 SRP-250
		3	SRP-270 SRP-300
		4	SRP-350
		5	CITIZEN3550/3551
		6	CITIZEN810
		7	CITIZEN230
		8	EPSON TMT88-2
		9	EPSON U200
		10	EPSON U295
		11	EPSON U300
		12	EPSON U325
		13	EPSON U375
		14	STAR SP-200
		15	STAR SP-298
		16	STAR SP-300
17	STAR TSP-200		

N1	OPTION	N2	VALUE
12	Pole Display	0	EPSON
		1	ICD
13	EFT Type	0	EFT GLED
		1	EFT INGE
		2	RESERVED
		3	TYRO EFTPOS (EPROM v3.8R)
		4	EFT NZINGE (EPROM v5.8R)
14	EFT Config Byte	0 – 127	0
15	EFT Currency	0	NONE
		1	DM
		2	EURO
16	EFT Password	0- 99999999	0

※Default values have been highlighted in **bold** print

*Remote Journal Printer

Program Mode Programming

Default Programming

- All keyboard PLUs are **Taxable, Preset** and **Override**, without entry limits by default status programming of "40000000".
- All system options are set to **0** in default programming, unless otherwise noted. Change only the options that will deviate from default programming. There is no need to re-enter an option status of **0**, since **0** is its original setting.
- All programming (unless otherwise noted) is done with the control lock in the **PGM-Mode**. Each section details a specific area of register programming.
- The Default program is set to **10.000% VAT on Tax 1** and the description is set to **GST** already.

Descriptor Programming Methods

Descriptors are programmable for PLUs, function keys, groups, clerks and the logo/messages. There are two methods available to program descriptors, the *Alpha Overlay* and the *Descriptor Code* Methods. *Alpha Overlay* Method is the default programming method, to switch between two methods, please see *Option #25-1* of "System Option Programming" in "Program Mode Programming".

This chapter describes both methods. *ER-5200/40/M* use *Alpha Overlay* Method by default and *ER-5215/M* use *Descriptor Code* Method by default. You can select each method by System option programming.

Alpha Overlay Method

The *Alpha Overlay* layout for each model is shown below. During descriptor programming, the keyboard button function change to the layout.

ER-5200/ER-5200M Alpha Keyboard Overlay

Without requirement of using the **European characters** in the descriptions, *Alpha Overlay* Method is an easy and fast method to program a descriptor

!	@	#	\$	%	^	&	*	()	-	+								
Q	W	E	R	T	Y	U	I	O	P	<	>								
A	S	D	F	G	H	J	K	L	;	'	?	CLEAR		X/TIME					
Z	X	C	V	B	N	M	,	.	/	:	=	7	8	9					
CAPS	DOUBLE	SPACE	SPACE	SPACE	SPACE	SPACE	CAPS	DOUBLE	BACK SPACE	"		4	5	6					
												1	2	3	SBTL				
												0	00	•	CASH				

ER-5240/ER-5240M Alpha Keyboard Overlay

Without requirement of using the **European characters** in the descriptions, *Alpha Overlay* Method is an easy and fast method to program a descriptor

					!	@	#	\$	%	^	&	*	()					
			CLEAR	X/TIME	Q	W	E	R	T	Y	U	I	O	P					
		7	8	9	A	S	D	F	G	H	J	K	L	;					
		4	5	6	Z	X	C	V	B	N	M	,	CHECK						
		1	2	3	-	+	<	>		?	:	=	SBTL						
		0	00	•	CAPS	DOUBLE	SPACE	DOUBLE	BSPACE	"	.	/	CASH						

Descriptor Code Method

If you customize your keyboard by covering key locations, or by installing double or quad size keys, you will need to program descriptors using the *Descriptor Code* Method.

Descriptor Code Chart

CHAR	Ç	ü	é	â	ä	à	å	ç	ê	ë
CODE	001	002	003	004	005	006	007	008	009	010
CHAR	è	ï	î	ì	Ä	Å	É	æ	Æ	ð
CODE	011	012	013	014	015	016	017	018	019	020
CHAR	ö	ò	û	ù	ÿ	Ö	Ü	¢	£	¥
CODE	021	022	023	024	0250	026	027	028	029	030
CHAR	€	SPACE	!	"	#	\$	%	&	'	(
CODE	031	032	033	034	035	036	037	038	039	040
CHAR)	*	+	,	-	.	/	0	1	2
CODE	041	042	043	044	045	046	047	048	049	050
CHAR	3	4	5	6	7	8	9	:	;	<
CODE	051	052	053	054	055	056	057	058	059	060
CHAR	=	>	?	@	A	B	C	D	E	F
CODE	061	062	063	064	065	066	067	068	069	070
CHAR	G	H	I	J	K	L	M	N	O	P
CODE	071	072	073	074	075	076	077	078	079	080
CHAR	Q	R	S	T	U	V	W	X	Y	Z
CODE	081	082	083	084	085	086	087	088	089	090
CHAR							a	b	c	d
CODE	091	092	093	094	095	096	097	098	099	100
CHAR	e	f	g	h	i	j	k	l	m	n
CODE	101	102	103	104	105	106	107	108	109	110
CHAR	o	p	q	r	s	t	u	v	w	x
CODE	111	112	113	114	115	116	117	118	119	120
CHAR	y	z	BACK SPACE			Double				
CODE	121	122	123			999				

Tax Programming

The *ER-5200/ER-5200M series* has the capability to support four separate taxes.

Taxes can be calculated as either a straight percentage rate of between 0.001% and 99.999%, or a 60 break point tax table. Each tax may be either an add-on tax (added to the cost of a taxable item), or a value added tax (VAT) that is included in the price of the item.

Tax rate 4 may be set to function as the Canadian Goods & Services Tax (GST). Definitions for tax rates 1, 2, 3 & 4 are made as part of tax programming.

- **The Default program is set to 10.000% VAT on Tax 1 and the description is set to GST already.**
- If you are entering a tax rate (add-on or VAT), see "Straight Percentage Tax Rate Programming" to enter the percentage rate.
- If you are entering a Canadian Goods and Services Tax (GST), use tax rate 4 for the GST tax, and use tax rates 1, 2 and/or 3 for any other provincial tax or taxes. See "Straight Percentage Tax Rate Programming" to enter the GST status and percentage rate.

Important Note: After you have entered your tax program(s), test for accuracy by entering several transactions of different dollar amounts. Carefully check to make sure the tax charged by the cash register matches the tax on the printed tax chart for your area. As a merchant, you are responsible for accurate tax collection. If the cash register is not calculating tax accurately, contact your dealer for assistance.

Descriptor - Program 80

- Refer to "Program 80 - Function Key Descriptor"

Straight Percentage Tax Rate Programming

When tax requirements may be met using a straight percentage rate, use the following method to program a tax as a straight percentage.

Programming Straight Percentage Tax Rates and Status

1. Turn the control lock to the **PGM-Mode**.
2. If the tax is a percentage rate, with a decimal. (0.000-99.999). It is not necessary to enter preceding zeros. For example, for 6%, enter 06.000 or 6.000.
3. For the type of tax:

If the tax is a percentage added to the sale (normal add on tax), enter:	0
If the tax is a percentage value added tax (VAT; calculated as part of the sale), enter:	2

4. Enter 0 here for all taxes, unless if you are programming tax 4 as a Canadian GST. If tax 4 is a Canadian GST, enter the sum of the options below:

OPTION	VALUE	=	SUM
GST (tax 4) is taxable by rate 1?	Yes = 1 No = 0		
GST (tax 4) is taxable by rate 2?	Yes = 2 No = 0		
GST (tax 4) is taxable by rate 3?	Yes = 4 No = 0		

5. Press the Tax Shift key for the tax you are programming.
6. Press the **CASH** key to end programming.

Tax Rate Programming Flowchart

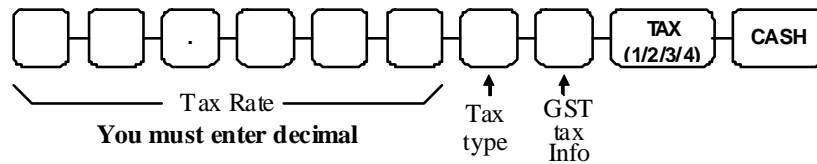

The Default program is set to 10.000% VAT on Tax 1 and the description is set to GST already.

PLU Programming

All PLUs, whether they are registered by pressing a PLU key on the keyboard, or by entering the PLU number and pressing the **PLU** key, have the same programming options. These options are set through separate programs:

- **Program 100 - PLU Status Programming** determines whether the PLU is open, preset or inactive. Also selected here are tax, food stamp, scale, negative, single item, hash, gallonage, compulsory number entry, compulsory validation, compulsory condiment and print options.
- **Program 110 - PLU Auto Tare Programming.**
- **Program 150 - PLU Group Assignment Programming** allows you to select up to three groups where each PLUs sales will accumulate.
- **Program 200 - PLU Price/HALO Programming** determines the PLU price if the PLU is preset or the high amount lock out (HALO) if the PLU is open.
- **Program 250 - PLU Stock Amount Programming** allows you to add stock to the PLU sales counters for PLUs you have designated as stock keeping PLUs.
- **Program 300 - PLU Description Programming** allows you to set a unique, up to 18 - character descriptor for each PLU.
- **Program 350 - PLU Link Programming** allows you to link a PLU to another PLU, so that registration of the first PLU will automatically trigger registration of the linked PLU.
- **Program 400 - PLU Delete Programming** allows you to delete the PLU.
- **Program 450 - PLU Mix & Match Programming.**

Program 100 - PLU Status Programming

PLUs default to Taxable by Rate 1. i.e GST

1. Turn the control lock to the **PGM-Mode**.
2. To begin the program, enter **1 0 0**, press the **SBTL** key.

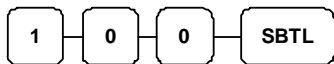

3. Select the PLU or PLUs you wish to program in one of the following ways:

- Press a PLU on the keyboard, or



- Press the first PLU in a range of PLUs that are to receive the same setting then press the last PLU, or



- Enter up to 15 digit number of the PLU and press the **PLU** key, or

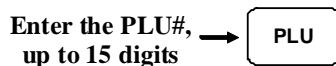

- Enter the number of the first PLU in a range of PLUs that are to receive the same setting; press the **PLU** key. Enter the last PLU number in the range; press the **PLU** key, or

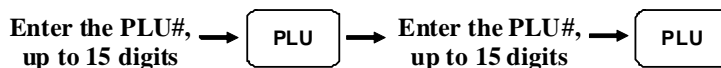

- For a **barcode item**, scan the barcode.

4. Refer to the "PLU Status Chart" to determine the values for **N1** through **N9**. (If an address offers more than one option, add the values for each option and enter the sum. For example, if you wish the PLU to be taxable by rates 1 and 3, add the values for your choices, 1 + 4, and enter the sum "5" for address N5.) Enter the values you have selected, press the **X/TIME** key. (**You do not need to enter preceding zeros**. For example, if you are only selecting a value for **N9**, i.e. auto tare by number 1, just enter 1.)

Australian GST status is preset by default.

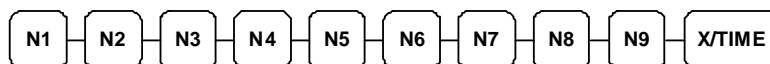

5. To program additional PLUs, repeat from step 3, or press the **CASH** key to finalize the program.



PLU Status Chart

Address	Program Option	Value	=	Sum
N1	PLU is preset price ?	Yes = 0 No = 1		
	PLU allows override of preset?	Yes = 0 No = 2		
	PLU is taxable by rate 1(GST)?	Yes = 4 No = 0		
N2	PLU is taxable by rate 2?	Yes = 1 No = 0		
	PLU is taxable by rate 3?	Yes = 2 No = 0		
	PLU is taxable by rate 4?	Yes = 4 No = 0		
N3	PLU is food stamp eligible?	Yes = 1 No = 0		
	PLU is a negative item?	Yes = 2 No = 0		
	PLU is hash ?	Yes = 4 No = 0		
N4	PLU is single item ?	Yes = 1 No = 0		
	Compulsory non-add number entry ?	Yes = 2 No = 0		
	PLU is gallonage ?	Yes = 4 No = 0		
N5	PLU keeps inventory ?	Yes = 1 No = 0		
	PLU is inactive ?	Yes = 2 No = 0		
	PLU is scalable ? (Also make N6 +1)	Yes = 4 No = 0		
N6	PLU is auto-scale entry? (Also make N5 +4)	Yes = 1 No = 0		
	PLU is a condiment ?	Yes = 2 No = 0		
	Compulsory condiment entry?	Yes = 4 No = 0		
N7	Print PLU on receipt ?	Yes = 0 No = 1		
	Print PLU on detail ?	Yes = 0 No = 2		
	Print PLU on check ?	Yes = 0 No = 4		
N8	Print item's price on receipt?	Yes = 0 No = 1		
	Print item's price on check?	Yes = 0 No = 2		
	PLU is disabled PROMO function?	Yes = 4 No = 0		

Address	Program Option	Value	=	Sum
N9	PLU counter is not reset when a PLU Z report is done?	Yes = 1 No = 0		
	PLU is preset override in MGR control?	Yes = 2 No = 0		

*Default values have been highlighted in **bold** print

Program 110 - PLU Auto Tare Programming

NOTE: If this program has been performed, please also see **Program 1400 - Scale Tare Weight Programming** in **Program Mode Programming - Miscellaneous Programming** for more detail.

1. Turn the control lock to the **PGM-Mode**.
2. To begin the program, enter **1 1 0**, press the **SBTL** key

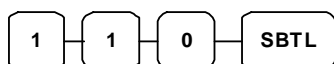

3. Select the PLU or PLUs you wish to program in one of the following ways:

- Press a PLU on the keyboard, or

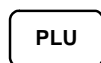

- Press the first PLU in a range of PLUs that are to receive the same setting then press the last PLU, or



- Enter up to 15 digit number of the PLU and press the **PLU** key, or

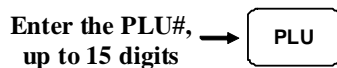

- Enter the number of the first PLU in a range of PLUs that are to receive the same setting; press the **PLU** key. Enter the last PLU number in the range; press the **PLU** key, or

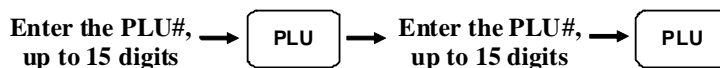

- For a barcode item, scan the barcode.

4. Enter a value (1-5) to indicate the number of the preprogrammed tare weight you want to automatically subtract when the PLU is used for scale entry (using an optional scale). Enter 0 to disable automatic tare subtraction, follow with **X/TIME** key.

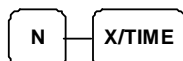

5. Program additional PLUs, repeat from step 3, or press the **CASH** key to finalize the program



Program 150 - PLU Group Assignment Programming

Each PLU may report to any three levels of 20 groups. Group totals appear on reports, so that you can track sales of different types of items. A group can also be used to designate items that are to print on an optional kitchen printer.

NOTE: The PLU will report to group "0", if not programmed to report to groups 1-20.

1. Turn the control lock to the **PGM-Mode**.
2. To begin the program, enter **1 5 0**, press the **SBTL** key.

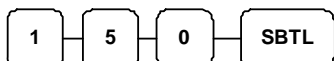

3. Select the PLU or PLUs you wish to program in one of the following ways:

- Press a PLU on the keyboard, or



- Press the first PLU in a range of PLUs that are to receive the same setting then press the last PLU, or



- Enter up to 15 digit number of the PLU and press the **PLU** key, or

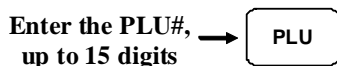

- Enter the number of the first PLU in a range of PLUs that are to receive the same setting; press the **PLU** key. Enter the last PLU number in the range; press the **PLU** key, or

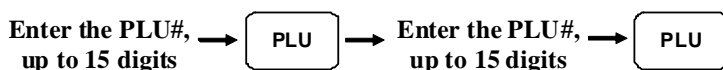

- For a **barcode item**, scan the barcode.

4. Enter up to three 2-digit numbers representing the groups where you wish to add the PLUs sales, i.e. enter **1 0** for group 10 or enter **0 4** for group four. If a PLU is link to group 03 as 1st group only, please enter **0 3 0 0 0 0**. Then press the **X/TIME** key.

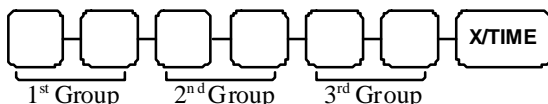

5. To program additional PLUs, repeat from step 3, or press the **CASH** key to finalize the program.



Program 200 - PLU Price/HALO Programming

NOTE: IF Price Level in the Memory Allocation is set to 2, the 2nd price level must be set as well. Price of level 2 may be \$0.00. Before changing price of one of the level, original prices has to be checked. Unchanged price of its level has to be entered as well.

If a PLU is set open, the number entered will be a HALO (high amount lock out). If a PLU is set preset, the amount entered will be a preset price. If a PLU is set with gallonage status, enter the price per liter here. (Enter price per liter in tenths of a cent, i.e. 1299 for \$1.29 9/10 per liter.)

1. Turn the control lock to the **PGM-Mode**.
2. To begin the program, enter **2 0 0**, press the **SBTL** key.

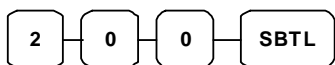

3. Select the PLU or PLUs you wish to program in one of the following ways:

- Press a PLU on the keyboard, or

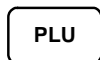

- Press the first PLU in a range of PLUs that are to receive the same setting then press the last PLU, or



- Enter up to 15 digit number of the PLU and press the **PLU** key, or

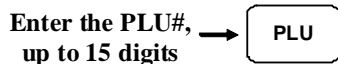

- Enter the number of the first PLU in a range of PLUs that are to receive the same setting; press the **PLU** key. Enter the last PLU number in the range; press the **PLU** key, or

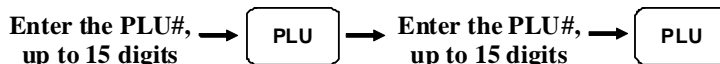

- For a **barcode item**, scan the barcode.

4. If the PLU is open, enter a HALO of up to 7 digits. If the PLU is preset, enter a preset price. Press **X/TIME** key.



1st Price/HALO

If the PLU **Price Level** is 2, repeat this with level 2 price again (or enter **\$0.00 price**).



2nd Price/HALO

5. To program additional PLUs, repeat from step 3, or press the **CASH** key to finalize the program.



Program 250 - PLU Stock Amount Programming

With this program, you can add stock to the PLU sales counters for PLUs you have designated as stock keeping PLUs. See “**Program 100 - PLU Status Programming**”. The stock number set here can be the amount of stock that is being added to the current level, or optionally, it can be the new total stock level. See **option #18** in “**System Option**” to set this option.

1. Turn the control lock to the **PGM-Mode**.
2. To begin the program, enter **2 5 0**, press the **SBTL** key.

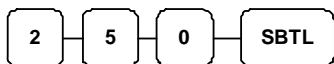

3. Select the PLU or PLUs you wish to program in one of the following ways:

- Press a PLU on the keyboard, or



- Press the first PLU in a range of PLUs that are to receive the same setting then press the last PLU, or

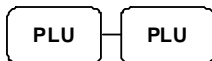

- Enter up to 15 digit number of the PLU and press the **PLU** key, or

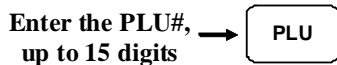

- Enter the number of the first PLU in a range of PLUs that are to receive the same setting; press the **PLU** key. Enter the last PLU number in the range; press the **PLU** key, or

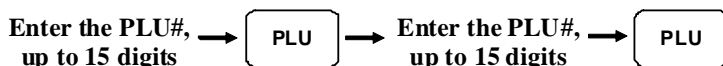

- For a **barcode item**, scan the barcode.

4. Enter the stock amount you wish to add (up to six digits), press the **X/TIME** key.



Stock Amount

5. To program additional PLUs, repeat from step 3, or press the **CASH** key to finalize the program.



Program 300 - PLU Description Programming

Program descriptions by typing description on the alpha keyboard overlay or by entering three digit alpha character codes. **To use three digit alpha character codes you must select 'No' in system option #25 (See "System Option Programming").** Also see **Descriptor Programming Methods for Alpha Overlay** and/or **Descriptor Code Table**.

1. Turn the control lock to the **PGM-Mode**.
2. To begin the program, enter **3 0 0**, press the **SBTL** key.

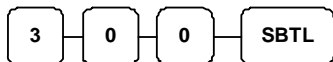

3. Select the PLU you wish to program in one of the following ways:

- Press a PLU on the keyboard, or



- Enter up to 15 digit number of the PLU and press the **PLU** key, or

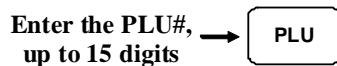

- For a **barcode item**, scan the barcode.

4. If you are programming using alpha overlay;



or,

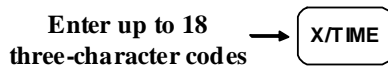

5. To program additional PLUs, repeat from step 3, or press the **CASH** key to finalize the program.



Program 350 - PLU Link Programming

PLU link programming allows you to link a PLU to another PLU, so that registration of the first PLU will automatically trigger registration of the linked PLU. For example, you may wish to link a bottle deposit with the sale of beverages, or you may wish to register a group of items normally sold together.

1. Turn the control lock to the **PGM-Mode**.
2. To begin the program, enter **3 5 0**, press the **SBTL** key.

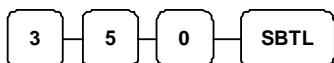

3. Select the PLU you wish to program in one of the following ways:

- Press a PLU on the keyboard, or

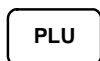

- Enter up to 15 digit number of the PLU then press the **PLU** key, or

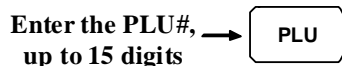

- For a **barcode item**, scan the barcode.

4. Enter the number of the PLU you wish the PLU linked to; press the **PLU** key. Or press the PLU key on the keyboard you wish the PLU linked to.

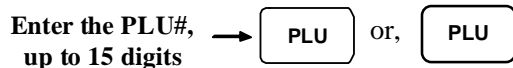

If you want to unlink,

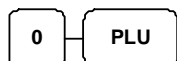

5. To program additional PLUs, repeat from step 3, or press the **CASH** key to finalize the program.



Program 400 - PLU Delete Programming

NOTE: To delete a PLU, all totals for the PLU must be cleared from Z reports (including Stock and PLU reports.)

1. Turn the control lock to the **PGM-Mode**.
2. To begin the program, enter **4 0 0**, press the **SBTL** key.

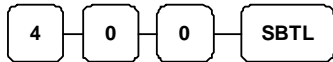

3. Select the PLU or PLUs you wish to program in one of the following ways:

- Press a PLU on the keyboard, or



- Press the first PLU in a range of PLUs that are to delete then press the last PLU, or



- Enter up to 15 digit number of the PLU and press the **PLU** key, or

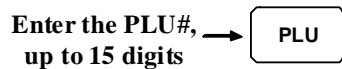

- Enter the number of the first PLU in a range of PLUs that are to delete and press the **PLU** key. Enter the last PLU number in the range; press the **PLU** key, or

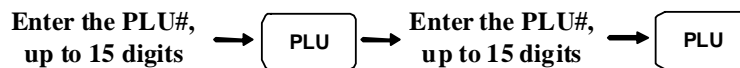

- For a **barcode item**, scan the barcode.

4. Press **X/TIME** key.



5. To program additional PLUs, repeat from step 3, or press the **CASH** key to finalize the program.



Program 450 - PLU MIX & MATCH Programming

1. Turn the control lock to the **PGM-Mode**.
2. To begin the program, enter **4 5 0**, press the **SBTL** key.

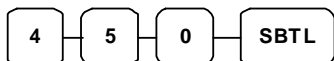

3. Select the PLU you wish to program in one of the following ways:

- Press a PLU on the keyboard, or



- Press the first PLU in a range of PLUs that are to receive the same setting then press the last PLU, or



- Enter up to 15 digit number of the PLU and press the **PLU** key, or

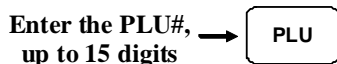

- Enter the number of the first PLU in a range of PLUs that are to receive the same setting; press the **PLU** key. Enter the last PLU number in the range; press the **PLU** key, or

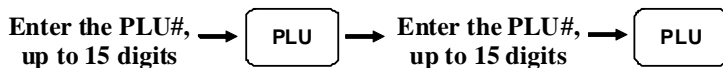

- For a **barcode item**, scan the barcode.

4. Enter the number of the Mix & Match Table (1-20); press the **X/TIME** key.

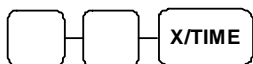

5. To program additional PLUs, repeat from step 3, or press the **CASH** key to finalize the program.



System Option Programming

Refer to the “**System Option Table**” to review the system options. Read each option carefully to determine if you wish to make any changes. Default value has been highlighted in **bold print**.

NOTE: Because after Memory All Clear all options settings are automatically set to default, you do not need to program this section unless you wish to change the default status.

Program 30 - System Option Programming

Programming a System Option:

1. Turn the control lock to the **PGM-Mode**.
2. Enter **3 0**, press the **SBTL** key.
3. Enter a system option address, press the **X/TIME** key.
4. Enter the number representing the status you have selected, or if there is more than one decision to be made in an address, add the values representing your choices for each decision and enter the sum. Press the **SBTL** key.
5. Repeat from step 3 for each system option you wish to change.
6. Press the **CASH** key to end system option programming.

System Option Flowchart

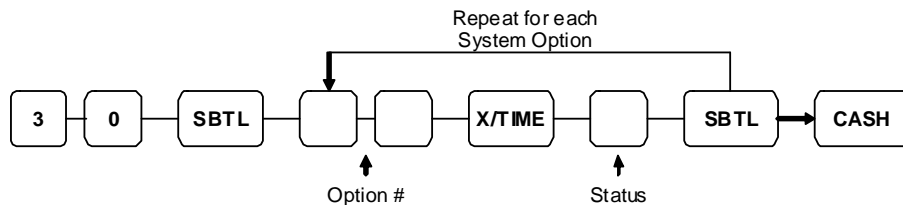

※Default values have been highlighted in **bold print**

System Option Table

Address	SYSTEM OPTION	VALUE	=	SUM
1	Beeper is active?	Yes = 0 No = 1		
	Clerk operation is real clerk key?	Yes = 2 No = 0		
2	Clerk sign on method is:	direct entry =	0	
		code entry =	1	
3	Clerks are:	pop-up =	Yes = 1	
		stay down =	No = 0	
4	Drawer needs to be shut to operate?	Yes = 0 No = 1		
	Activate open drawer Alarm?	Yes = 2 No = 0		
5	The number of seconds before the open drawer warning tone sounds (1 - 99)	30		
6	Allow the post tender function?	Yes = 1 No = 0		
	Open drawer on post tender?	Yes = 0 No = 2		
	Allow multiple receipts? (See Print Opt. #24)	Yes = 4 No = 0		
7	Cash Declaration Required before Z Financial report? (Also see Sys Opt #25-3)	Yes = 1 No = 0		
	Allow negative balance sales in the X control lock position only?	Yes = 2 No = 0		
8	Allow zero balance sales in the X control lock position only?	Yes = 1 No = 0		
	Reset Consecutive Number after a financial report?	Yes = 2 No = 0		
9	Reset Grand Total after Z financial Report?	Yes = 1 No = 0		
	Cash drawer will open when reports are run?	Yes = 0 No = 2		
	Open drawer during training mode?	Yes = 0 No = 4		
10	Decimal place (0,1,2,3)	2		
11	Date format is:	MMDDYY =	0	
		DDMMYY =	1	
		YYMMDD =	2	

Address	SYSTEM OPTION	VALUE	=	SUM
12	Percentage and Tax calculations will:	round up at 0.005 =	0	
		always round up =	1	
		always round down =	2	
13	Split price calculations will:	round up at 0.005 =	0	
		always round up =	1	
		always round down =	2	
14	Compulsory Eat in T-out D-thru before tendering?		Yes = 1 No = 0	
	Hash is	Normal =	Yes = 0	
		Non Add =	No = 2	
15	Reset the Financial report Z counter after a Z1 Financial report?		Yes = 1 No = 0	
	Reset the Time report Z counter after a Z1 Time report?		Yes = 2 No = 0	
	Reset the PLU report Z counter after a Z1 PLU report?		Yes = 4 No = 0	
16	Reset the Clerk report Z counter after a Z1 Clerk report?		Yes = 1 No = 0	
	Reset the Group report Z counter after a Z1 Group report?		Yes = 2 No = 0	
17	Reset the Daily sale report Z counter after a Z2 Daily sale report?		Yes = 1 No = 0	
	Paper sensor is enabled?		Yes = 0 No = 2	
	Deactivate Split Pricing?		Yes = 4 No = 0	
18	Allow Direct Multiply?		Yes = 1 No = 0	
	Inventory (stock) counter programming	added to current level =	Yes = 2	
		replaces current level =	No = 0	
19	The number of numeric digits: 0 - 14 (0 is no limit)		0	
20	Direct Multiply more than one digit?		Yes = 1 No = 0	
	Tender validation amount is:	amount tendered =	Yes = 2	
		amount of sale =	No=0	
21	Display add price of linked item?		Yes = 1 No = 0	
	Allow sale when stock reaches "0"?		Yes = 0 No = 2	
	Allow Australian Rounding on subtotal? (Also see Sys Opt #22-1, #32-2, and #32-3) (NB Turn New Zealand Rounding OFF first)		Yes = 4 No = 0	

Address	SYSTEM OPTION	VALUE	=	SUM	
22	Allow Australian Rounding on cash? (Also see Sys Opt #21-3, #32-2, and #32-3) (NB Turn New Zealand Rounding OFF first)	Yes = 1 No = 0			
	Allow Z stock report ?	Yes = 0 No = 2			
23	Training mode	enter =	Yes = 1		
		exit =	No = 0		
24	Activate autocutter? (ER-5200M series default is Yes; ER-5200 series default is No, set Yes will generate the 'A[]' error message)	Yes = 1 No = 0			
25	Descriptor entry method is overlay.	ER-5200/40	Keyboard overlay =	Yes = 0	
			Character code =	No = 1	
		ER-5215	(Fixed)	No = 1	
	% is affect to net sale?		Yes = 0 No = 2		
	Disable Cash Declaration ? (Also see Sys Opt #7-1)		Yes = 4 No = 0		
26	Check Track Methods:	Table Management =	No = 0		
		Clerk Interrupt =	Yes = 1		
	VAT shift affect the whole receipt?		Yes = 2 No = 0		
	Not count in memory in void mode?		Yes = 4 No = 0		
27	Disable Price Level keys:	Neither =	0		
		Level 1 =	1		
		Level 2 =	2		
28	Price level is:	Pop-up after item =	0		
		Pop-up after sale =	1		
		Stay-down =	2		
29	Modifier is:	Pop-up after item =	0		
		Pop-up after sale =	1		
		Stay-down =	2		
30	Embedded price barcode type (0/1/2/3/4/7)	0			
31	Enable keyboard PLU function (EPROM v1.1 ER-52xxM; v2.1 ER-52xx)	Yes = 1 No = 0			
	Reset GST after service on Hard Check (EPROM v1.3 ER-52xxM; v2.3 ER-52xx)	Yes = 2 No = 0			
	Use standard check digit calculation (EPROM v1.5 ER-52xxM; v2.4 ER-52xx)	Yes = 0 No = 4			

Address	SYSTEM OPTION	VALUE	=	SUM
32	Allow Z financial report with open Clerk Interrupt sales (Modified EPROM v4.9R) Allow Z financial report with open checks (Modified EPROM v4.0R) Allow Z financial report with open check or interrupted sales (Added EPROM v3.4-ER-52xx; v3.3R-ER-52xxM)	Yes = 1 No = 0		
	Allow New Zealand rounding on Subtotal? (Added EPROM v3.6R-ER-52xx; v3.2R-ER-52xxM) (Also see Sys Opt #21-3, #22-1, and #32-3) (NB Turn AU rounding OFF first)	Yes = 2 No = 0		
	Allow New Zealand rounding on Cash? (Added EPROM v3.6R-ER-52xx; v3.2R-ER-52xxM) (Also see Sys Opt #21-3 #22-1, and #32-3) (NB Turn AU rounding OFF first)	Yes = 4 No = 0		
33	Disable Line Find on Slip Printer (EPROM v4.5R)	Yes = 1 No = 0		

Note: Price Embedded Barcode Format

Barcode Format	1 st	2 nd	3 rd	4 th	5 th	6 th	7 th	8 th	9 th	10 th	11 th	12 th	13 th	
Type 1	D1	D2	I1	I2	I3	I4	I5	S	P1	P2	P3	P4	C	(5 and 4)
Type 2	D1	D2	I1	I2	I3	I4	S	P1	P2	P3	P4	P5	C	(4 and 5)
Type 3	D1	D2	I1	I2	I3	I4	I5	I6	P1	P2	P3	P4	C	(6 and 4)
Type 4	D1	D2	I1	I2	I3	I4	I5	P1	P2	P3	P4	P5	C	(5 and 5)
Type 7	D1	D2	I1	I2	I3	I4	I5	W1	W2	W3	W4	W5	C	(5 and 5)

D1, D2 = Department Number (02, 20 ~ 29)
I1 ~ I6 = Item Code digits
P1 ~ P5 = Price digits
W1 ~ W5 = Weight digits
S = Check sum digit for price
C = Check sum digit for all characters

Type 0: Price Embedded Barcode not used

Type 1: 2 digits Department Number, 5 digits Item Code, 1 digit Price Checksum, 4 digits Price, and 1 digit Checksum.

Type 2: 2 digits Department Number, 4 digits Item Code, 1 digit Price Checksum, 5 digits Price, and 1 digit Checksum.

Type 3: 2 digits Department Number, 6 digits Item Code, 4 digits Price, and 1 digit Checksum.

Type 4: 2 digits Department Number, 5 digits Item Code, 5 digits Price, and 1 digit Checksum.

Type 7: 2 digits Department Number, 5 digits Item Code, 5 digits **Weight**, and 1 digit Checksum.

Print Option Programming

Refer to the “**Print Option Table**” to review the print options. Read each option carefully to determine if you wish to make any changes. Default value has been highlighted in **bold print**

NOTE: Because after Memory All Clear all options settings are automatically set to default, you do not need to program this section unless you wish to change the default status.

Program 40 - Print Option Programming

Programming a Print Option:

1. Turn the control lock to the **PGM-Mode**.
2. Enter **4 0**, press the **SBTL** key.
3. Enter a print option address, press the **X/TIME** key.
4. Enter the number representing the status you have selected, or if there is more than one decision to be made in an address, add the values representing your choices for each decision and enter the sum. Press the **SBTL** key.
5. Repeat from step 3 for each print option you wish to change.
6. Press the **CASH** key to end print option programming.

Print Option Flowchart

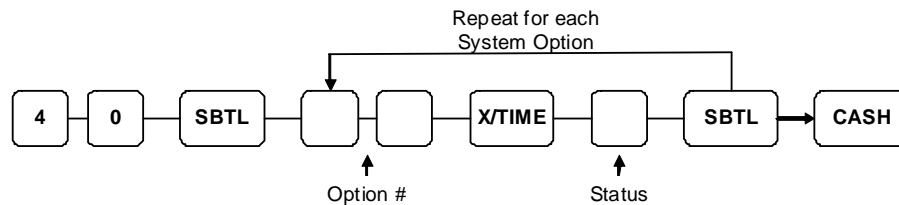

※Default values have been highlighted in **bold print**

Print Option Table

Address	PRINT OPTION	VALUE	=	SUM
1	Print media totals on clerk report?	Yes = 1 No = 0		
	Print tax symbol ?	Yes = 0 No = 2		
2	Void/Return totals will print on the Financial report?	Yes = 0 No = 1		
	Audaction total will print on the Financial report?	Yes = 2 No = 0		
3	Skip media totals with zero activity on the Financial report?	Yes = 0 No = 1		
	Skip media totals with zero activity on the Clerk report?	Yes = 0 No = 2		
	Print Clerk report at the end of the Financial report?	Yes = 4 No = 0		
4	Print sale item number (PLU number) ?	Yes = 1 No = 0		
	Print PLU with zero totals on report?	Yes = 2 No = 0		
	Subtotal is printed when the SBTL key is pressed?	Yes = 4 No = 0		
5	Print percentage of sales on the PLU report?	Yes = 1 No = 0		
	Print consecutive number counter on receipt?	Yes = 0 No = 2		
6	Print date on receipt?	Yes = 0 No = 1		
	Print time on receipt?	Yes = 0 No = 2		
	Print machine number on receipt?	Yes = 0 No = 4		
7	Print clerk name on receipt?	Yes = 0 No = 1		
	Print Z counter on reports?	Yes = 0 No = 2		
8	Home Currency symbol (see note1 below)	\$		
9	Print receipt when sign on/off ?	Yes = 0 No = 1		
	Print Grand total on the X Financial report ?	Yes = 0 No = 2		
	Print Grand total on the Z Financial report ?	Yes = 0 No = 4		

Address	PRINT OPTION	VALUE	=	SUM
10	Print Gross total on the X Financial report ?	Yes = 0 No = 1		
	Print Gross total on the Z Financial report ?	Yes = 0 No = 2		
11	Print the subtotal without tax on the receipt?	Yes = 1 No = 0		
	Tax amount to print on receipt is:	Combine =	Yes = 2	
		Itemize =	No = 0	
12	Print the tax amount on receipt?	Yes = 0 No = 1		
	Print taxable totals ?	Yes = 2 No = 0		
	Print the tax rate ?	Yes = 4 No = 0		
13	Print a breakdown of the VAT eligible sale?	Yes = 1 No = 0		
	Print training mode message on the receipt during training mode operations?	Yes = 2 No = 0		
14	Currency Symbol: (see note2 below)	CONV. #1 =	.	
15		CONV. #2 =	.	
16		CONV. #3 =	.	
17		CONV. #4 =	.	
18	Print the kitchen printer order number on receipt?	Yes = 0 No = 1		
	Print the item's price on the kitchen printer / requisition?	Yes = 2 No = 0		
19	Send/print order to the kitchen printer / requisition in void mode ?	Yes = 0 No = 1		
	Send/print order to the kitchen printer / requisition in training mode ?	Yes = 2 No = 0		
	Print round amount on the kitchen printer / requisition?	Yes = 4 No = 0		
20	Combine like items on the kitchen printer / requisition?	Yes = 0 No = 1		
	Consolidation of like items on check track ?	Yes = 0 No = 2		
	Chooses volume unit when the PLU is gallonage.	Gallons =	0	
Liters =		4		

Address	PRINT OPTION	VALUE	=	SUM	
21	Print preamble message on receipt?	Yes = 0 No = 1			
	Print postamble message on receipt?	Yes = 0 No = 2			
	Print preamble message on the guest check?	Yes = 4 No = 0			
22	Print postamble message on the guest check?	Yes = 1 No = 0			
	Print preamble/postamble message on the journal receipt?	Yes = 2 No = 0			
23	Print average items per customer on the Financial report?	Yes = 0 No = 1			
	Print average sales per customer on the Financial report?	Yes = 0 No = 2			
24	Issue a second receipt for the same transaction? (Buffer receipt issue when receipt printer is on) (Also see Sys Opt #6)	Yes = 1 No = 0			
	Priority print by group on the kitchen printer?	Yes = 2 No = 0			
	Print PLU number on the receipt?	Yes = 4 No = 0			
25	Not print when polling reports? (Note: this setting is equivalent to 'print when polling reports – Yes')	Yes = 1 No = 0			
	Print PLU number on PLU report?	Yes = 2 No = 0			
	Grand total is:	net sale =	Yes = 4		
		gross sale =	No = 0		
26	Print journal font	small =	No = 0		
		normal =	Yes = 1		
	Print journal reverse ?	Yes = 2 No = 0			
	Journal printer is off?	Yes = 4 No = 0			
27	Send order to the kitchen printer when the SBTL key is pressed ?	Yes = 1 No = 0			
	Print date on service on hard check?	Yes = 2 No = 0			
28	Print preamble graphic logo on receipt?	Yes = 1 No = 0			
	Print postamble graphic logo on receipt?	Yes = 2 No = 0			

Address	PRINT OPTION	VALUE	=	SUM
29	Print preamble graphic logo on the guest check?	Yes = 1 No = 0		
	Print postamble graphic logo on the guest check?	Yes = 2 No = 0		
30	Print preamble graphic logo	Default = Yes = 0		
		User = No = 1		
	Print postamble graphic logo	Default = Yes = 0		
		User = No = 2		
31	Number of Pre-feeding lines . (0 - 5) on receipt	0		
32	Number of Post-feeding lines . (0 - 5) on receipt	0		
33	Print CHECK# Line on the Guest Check (EPROM v5.1R)	Yes = 1 No = 0		

※Default values have been highlighted in **bold** print

NOTE 1: Print Option# 8 - Users outside of the USA can designate a different currency symbol. To select a different symbol, type descriptors on the alpha keyboard overlay or enter three digit alpha character codes. **To use three digit alpha character codes you must select 'No' in system option #25(See "System Option Programming"). Also see Descriptor Programming Methods for Alpha Overlay and/or Descriptor Code Table.**

NOTE 2: Print Option# 14,15,16,17 - If you are using the currency conversion feature, you can select the appropriate symbol for each foreign currency you are accepting. To select a different symbol, type descriptors on the alpha keyboard overlay or enter three digit alpha character codes. **To use three digit alpha character codes you must select 'No' in system option #25 (See "System Option Programming). Also see Descriptor Programming Methods for Alpha Overlay and/or Descriptor Code Table.**

Function Key Programming

Three programs are used to program function keys:

- **Program 70 - Function Key Options Programming** is used to set each keys individual options
- **Program 80 - Function Key Descriptor Programming** is used to program a 18 character alpha numeric descriptor
- **Program 90 - Function Key HALO or Percentage Rate Programming** is used to set a high amount limit (HALO)

(for percentage key is discount/surcharge rate.)

In this chapter you will find:

- General instructions for programs 70, 80 and 90.
- Specific programming instructions for each function key.

To change descriptors on reports see:

***“Program 701 - Financial Report Message Programming” and
“Program 710 - Clerk Report Message Programming” also.***

Program 70 - Function Key Options Programming

Use Program 70 to set options for function keys. Because of the differences inherent in function keys, individual options will be different. See the specific instructions for each key in this chapter to find the options for each key.

1. Turn the control lock to the **PGM-Mode**.
2. To begin the program, enter **7 0**, press the **SBTL** key.



3. Enter the values for the option digit or digits. Depending on the function key you are programming, you may enter up to six digits **N1** through **N6**. Determine the values for **N1** through **N6** by referring to the specific function key information that follows. (**You do not need to enter preceding zeros**. For example, if the function key offers six digits, **N1** through **N6** and you are only selecting a value for **N6**, just enter the value for **N6**.) Press the function key you wish to program.

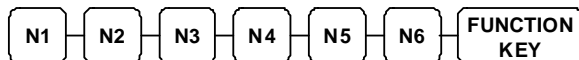

4. To program additional function keys, repeat from step 3, or press the **CASH** key to finalize the program.



Program 80 - Function Key Descriptor Programming

Program descriptions by typing description on the alpha keyboard overlay or by entering three digit alpha character codes. **To use three digit alpha character codes you must select 'No' in system option #25** (See "System Option Programming). Also see **Descriptor Programming Methods for Alpha Overlay** and/or **Descriptor Code Table**.

1. Turn the control lock to the **PGM-Mode**.
2. To begin the program, enter **8 0**, press the **SBTL** key.

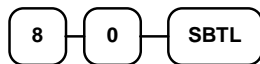

3. If you are programming *ER-5200/ER-5200M*,

Type up to 18 descriptor keys →  (EPROM v5.1R and earlier)

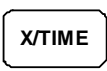
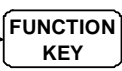
Type up to 18 descriptor keys →  →  (EPROM v5.2R and later)

or,

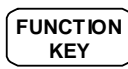
Enter up to 18 three-character codes → 

- If you are programming *ER-5240/ER-5240M*,

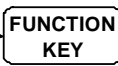
Type up to 18 descriptor keys →  → 

or,

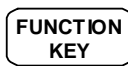
Enter up to 18 three-character codes → 

- If you are programming *ER-5215/ER-5215M*,

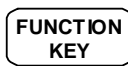
Enter up to 18 three-character codes → 

4. To program additional function keys, repeat from step 3, or press the **CASH** key to finalize the program.

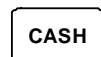

NOTE: The **MACRO (1 - 10)** function keys descriptor is programmed with **Programmed 711**. Please refer to **Miscellaneous Programming - Macro Name Programming**.

Program 90 - Function Key HALO or Percentage Rate Programming

Use Program 90 to program a high amount lock out (HALO) for a function key. Only specific keys require this program. For example, you can set a HALO for the **CASH**, **CHECK** or **CHARGE** keys. Refer to the specific function key programming information in this chapter to determine when the HALO option is available.

1. Turn the control lock to the **PGM-Mode**.
2. To begin the program, enter **9 0**, press the **SBTL** key.

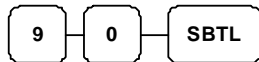

3. Enter a HALO of up to eight digits, (or "0" for no HALO).

**Enter 1-8 digit
HALO**

4. Press the function key on the keyboard you wish to program.



5. To program additional function keys, repeat from step 2, or press the **CASH** key to finalize the program.



ADD CHECK (Cafeteria Tray Total)

Options - Program 70

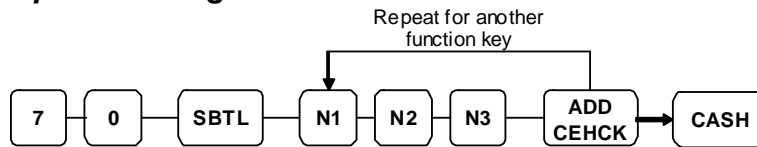

Address	OPTION	VALUE	=	SUM
N1	Key is inactive?	Yes = 1 No = 0		
	Compulsory before tendering?	Yes = 2 No = 0		
	Advance the consecutive # when this function is used?	Yes = 0 No = 4		
N2	Delete the preamble/postamble when this function is used?	Yes = 0 No = 1		
	Exempt tax 1?	Yes = 2 No = 0		
	Exempt tax 2?	Yes = 4 No = 0		
N3	Exempt tax 3?	Yes = 1 No = 0		
	Exempt tax 4?	Yes = 2 No = 0		
	Validation is compulsory?	Yes = 4 No = 0		

*Default values have been highlighted in **bold** print

Descriptor - Program 80

- Refer to "Program 80 - Function Key Descriptor"

CANCEL (Cancel a Sale)

Options - Program 70

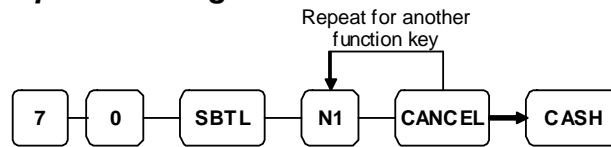

Address	OPTION	VALUE	=	SUM
N1	Key is inactive?	Yes = 1 No = 0		
	Key is active in X control lock position only?	Yes = 2 No = 0		
	Validation is compulsory?	Yes = 4 No = 0		

※Default values have been highlighted in **bold print**

Descriptor - Program 80

- Refer to “Program 80 - Function Key Descriptor”

HALO - Program 90

- Refer to “Program 90 - Function Key HALO ”

CASH

Options - Program 70

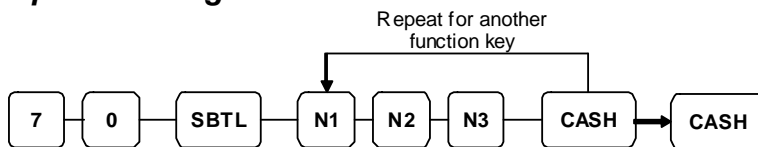

Address	OPTION	VALUE	=	SUM
N1	Amount tender is compulsory?	Yes = 1 No = 0		
	Allow over tendering and under tendering in X control lock position only?	Yes = 2 No = 0		
	Disable under tendering?	Yes = 4 No = 0		
N2	Open cash drawer?	Yes = 0 No = 1		
	Exempt tax 1?	Yes = 2 No = 0		
	Exempt tax 2?	Yes = 4 No = 0		
N3	Exempt tax 3?	Yes = 1 No = 0		
	Exempt tax 4?	Yes = 2 No = 0		
	Validation is compulsory?	Yes = 4 No = 0		

*Default values have been highlighted in **bold** print

Descriptor - Program 80

- Refer to "Program 80 - Function Key Descriptor"

HALO - Program 90

- Refer to "Program 90 - Function Key HALO"

CHARGE (1 ~ 8)

Options - Program 70

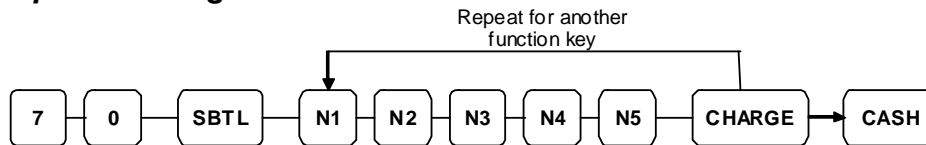

Address	OPTION	VALUE	=	SUM
N1	Amount tender is compulsory?	Yes = 1 No = 0		
	Allow over tendering and under tendering in X control lock position only?	Yes = 2 No = 0		
	Disable under tendering?	Yes = 4 No = 0		
N2	Open cash drawer?	Yes = 0 No = 1		
	Allow over tendering?	Yes = 2 No = 0		
	Non-add # entry compulsory?	Yes = 4 No = 0		
N3	Exempt tax 1?	Yes = 1 No = 0		
	Exempt tax 2?	Yes = 2 No = 0		
	Exempt tax 3?	Yes = 4 No = 0		
N4	Exempt tax 4?	Yes = 1 No = 0		
	Validation compulsory?	Yes = 2 No = 0		
	Send to EFT?	Yes = 4 No = 0		
N5	EFT Port (0-2)	0		

※Default values have been highlighted in **bold** print

Descriptor - Program 80

- Refer to "Program 80 - Function Key Descriptor"

HALO - Program 90

- Refer to "Program 90 - Function Key HALO"

CHECK (CHEQUE)

Options - Program 70

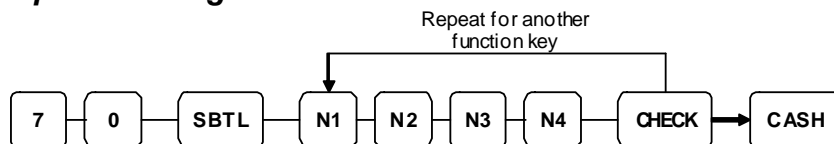

Address	OPTION	VALUE	=	SUM
N1	Amount tender is compulsory?	Yes = 1 No = 0		
	Allow over tendering and under tendering in X control lock position only?	Yes = 2 No = 0		
	Disable under tendering?	Yes = 4 No = 0		
N2	Open cash drawer?	Yes = 0 No = 1		
	Exempt tax 1?	Yes = 2 No = 0		
	Exempt tax 2?	Yes = 4 No = 0		
N3	Exempt tax 3?	Yes = 1 No = 0		
	Exempt tax 4?	Yes = 2 No = 0		
N4	Check endorsement compulsory?	Yes = 1 No = 0		
	Validation is compulsory?	Yes = 2 No = 0		

※Default values have been highlighted in **bold** print

Descriptor - Program 80

- Refer to "Program 80 - Function Key Descriptor"

HALO - Program 90

- Refer to "Program 90 - Function Key HALO"

CHECK (CHEQUE) CASHING

Options - Program 70

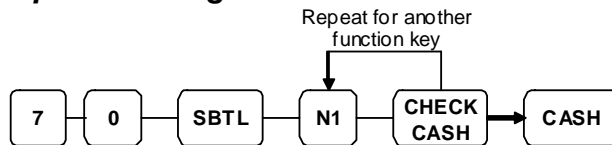

Address	OPTION	VALUE	=	SUM
N1	Key is inactive?	Yes = 1 No = 0		
	Key is active in X control lock position only?	Yes = 2 No = 0		
	Validation is compulsory?	Yes = 4 No = 0		

※Default values have been highlighted in **bold print**

Descriptor - Program 80

- Refer to "Program 80 - Function Key Descriptor"

HALO - Program 90

- Refer to "Program 90 - Function Key HALO"

CHECK (CHEQUE) ENDORSEMENT

Options - Program 70

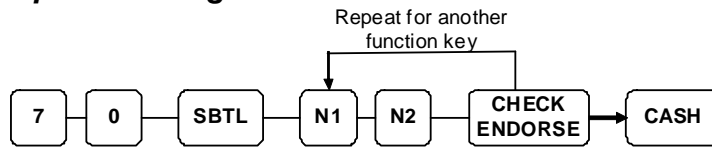

Address	OPTION	VALUE	=	SUM
N1	Key is inactive?	Yes = 1 No = 0		
	Print the amount of the check and endorsement message?	Yes = 2 No = 0		
	Print date?	Yes = 4 No = 0		
N2	Print time?	Yes = 1 No = 0		
	Print clerk?	Yes = 2 No = 0		
	Print consecutive number?	Yes = 4 No = 0		

*Default values have been highlighted in **bold** print

Descriptor - Program 80

- Refer to "Program 80 - Function Key Descriptor"

CHECK # (Bill or Account)

Options - Program 70

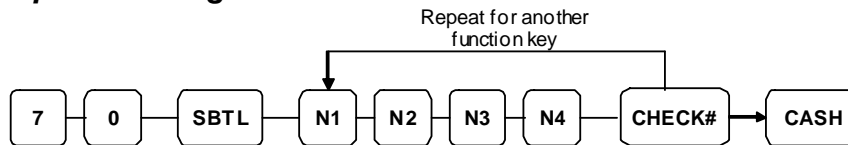

Address	OPTION	VALUE	=	SUM
N1	Key is inactive?	Yes = 1 No = 0		
	Required at Start of Sale?	Yes = 2 No = 0		
	Opening clerk has exclusive access?	Yes = 4 No = 0		
N2	Check track # and balance will print on receipt?	Yes = 0 No = 1		
	Check track # and balance will print on remote?	Yes = 0 No = 2		
	Allow only one check per table?	Yes = 4 No = 0		
N3	Check# is automatically assigned by register?	Yes = 1 No = 0		
	PBAL Key is used as Drive thru recall key?	Yes = 2 No = 0		
N4	Length of Check (0-9)	0		

※Default values have been highlighted in **bold** print

Descriptor - Program 80

- Refer to "Program 80 - Function Key Descriptor"

CURRENCY CONVERSION

Currency Conversion Rate - Program 90

1. Turn the control lock to the **PGM-Mode**.
2. To begin the program, enter **9 0**, press the **SBTL** key.

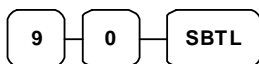

3. Enter the exchange rate of up to 7 digits (do not enter the decimal point), and then enter a number from 0 to 7 to indicate the decimal position. See "Currency Exchange Rate Programming Examples" below.

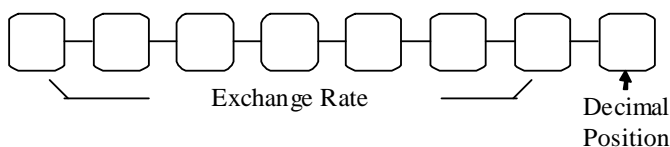

4. Press the function key on the keyboard you wish to program.

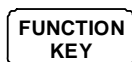

5. To program additional function keys, repeat from step 2, or press the **CASH** key to finalize the program.



Currency Exchange Rate Programming Examples

NOTE: Foreign currency exchange rates may be stated as "foreign currency in dollars", or "dollars in foreign currency". Use the rate stated in "dollars in foreign currency" when you are programming this section.

The US dollar (home currency) is worth 1.3720 Canadian dollars (foreign currency).

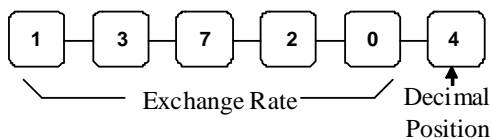

The US dollar (home currency) is worth 110.24 Japanese Yen (foreign currency).

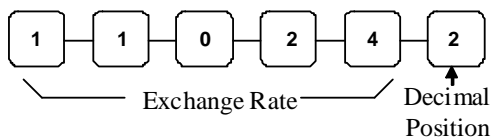

DRIVE THRU / EAT IN / TAKE OUT

Options - Program 70

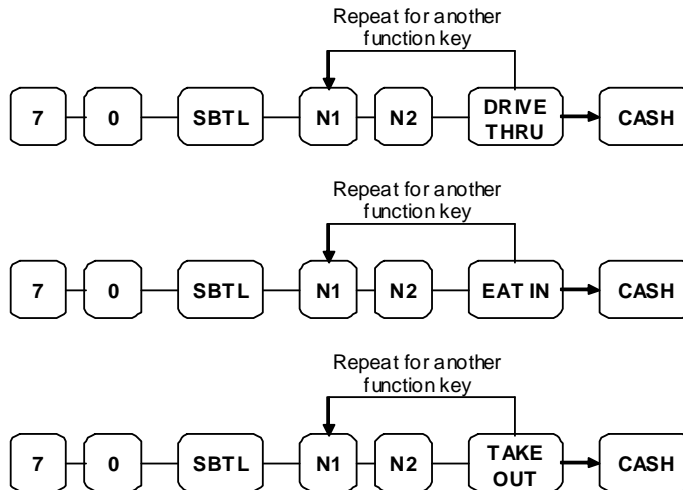

Address	OPTION	VALUE	=	SUM
N1	Exempt tax 1?	Yes = 1 No = 0		
	Exempt tax 2?	Yes = 2 No = 0		
	Exempt tax 3?	Yes = 4 No = 0		
N2	Exempt tax 4?	Yes = 1 No = 0		
	Validation is compulsory?	Yes = 2 No = 0		

※Default values have been highlighted in **bold** print

Descriptor - Program 80

- Refer to “Program 80 - Function Key Descriptor”

ERROR CORRECT

Options - Program 70

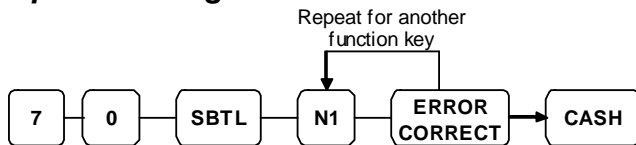

Address	OPTION	VALUE	=	SUM
N1	Key is inactive?	Yes = 1 No = 0		
	Key is active in X control lock position only?	Yes = 2 No = 0		
	Validation is compulsory?	Yes = 4 No = 0		

※Default values have been highlighted in **bold** print

Descriptor - Program 80

- Refer to “Program 80 - Function Key Descriptor”

HALO - Program 90

- Refer to “Program 90 - Function Key HALO”

F/S SUB

Options - Program 70

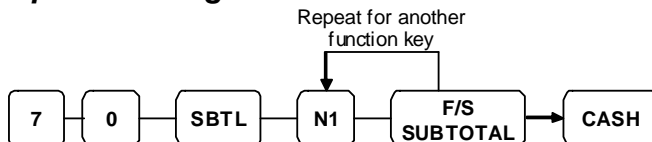

Address	OPTION	VALUE	=	SUM
N1	Key is inactive?	Yes = 1 No = 0		

※Default values have been highlighted in **bold** print

Descriptor - Program 80

- Refer to “Program 80 - Function Key Descriptor”

F/S TEND

Options - Program 70

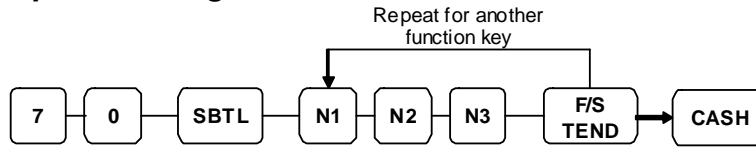

Address	OPTION	VALUE	=	SUM
N1	Exempt tax 1?	Yes = 1 No = 0		
	Exempt tax 2?	Yes = 2 No = 0		
	Exempt tax 3?	Yes = 4 No = 0		
N2	Exempt tax 4?	Yes = 1 No = 0		
	The tender is allowed in any amount?	Yes = 2 No = 0		
	Food stamp change Is issued in	Cash = 4 Food stamps = 0		
N3	Open cash drawer?	Yes = 0 No = 1		
	Validation is compulsory?	Yes = 2 No = 0		

※Default values have been highlighted in **bold** print

Descriptor - Program 80

- Refer to "Program 80 - Function Key Descriptor"

HALO - Program 90

- Refer to "Program 90 - Function Key HALO"

GUEST (Bill or Account)

Options - Program 70

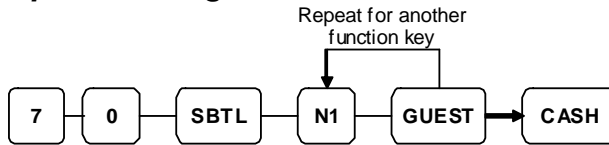

Address	OPTION	VALUE	=	SUM
N1	Required when opening a new check?	Yes = 1 No = 0		
	Before registering, enter a guest number?	Yes = 2 No = 0		
	Print Guest # at the kitchen printer?	Yes = 4 No = 0		

※Default values have been highlighted in **bold** print

Descriptor - Program 80

- Refer to “Program 80 - Function Key Descriptor”

LEVEL1 - 2 (Price Levels)

Options - Program 70

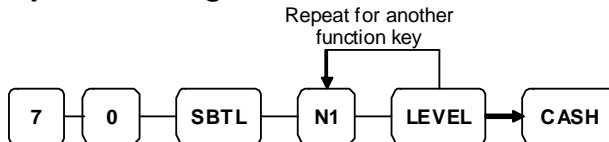

Address	OPTION	VALUE	=	SUM
N1	Print level description at the KP?	Yes = 1 No = 0		

※Default values have been highlighted in **bold** print

Descriptor - Program 80

- Refer to “Program 80 - Function Key Descriptor”

MACRO (1 ~ 10)

Options - Program 70

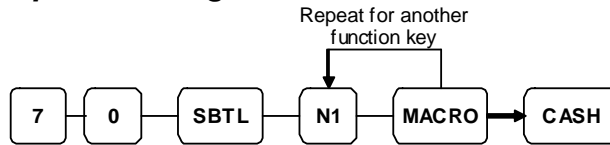

Address	OPTION	VALUE	=	SUM
N1	Key is active in X control lock position only? (EPROM v5.1R)	Yes = 1 No = 0		

※Default values have been highlighted in **bold** print

Descriptor - Program 711

- Refer to “Program 711 – Macro Name Programming” in Macro Name Programming

MDSE RETURN

Options - Program 70

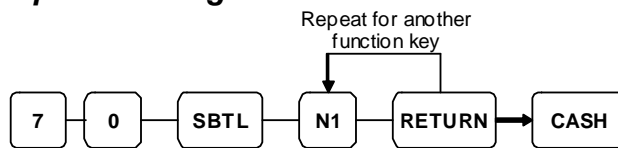

Address	OPTION	VALUE	=	SUM
N1	Key is inactive?	Yes = 1 No = 0		
	Key is active in X control lock position only?	Yes = 2 No = 0		
	Validation is compulsory?	Yes = 4 No = 0		

※Default values have been highlighted in **bold** print

Descriptor - Program 80

- Refer to “Program 80 - Function Key Descriptor”

HALO - Program 90

- Refer to “Program 90 - Function Key HALO”

MODIFIER (1 ~ 5)

Options - Program 70

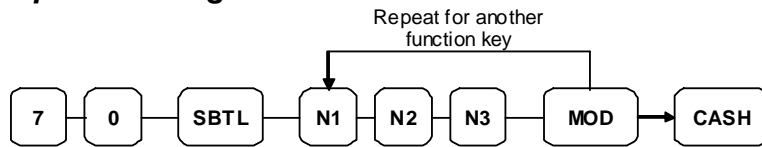

Address	OPTION	VALUE	=	SUM
N1	Key is active in X control lock position only?	Yes = 1 No = 0		
	Modify PLU#?	Yes = 2 No = 0		
N2	Print modifier descriptor on the guest check?	Yes = 1 No = 0		
	Print modifier descriptor on the receipt?	Yes = 2 No = 0		
N3	Value of affected digit (0-9)	1		

※Default values have been highlighted in **bold** print

Descriptor - Program 80

- Refer to "Program 80 - Function Key Descriptor"

Affect Digit - Program 90

Affect Digit (1-14) of PLU#

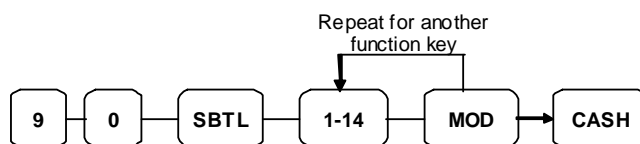

#/NS (Non Add#/No Sale)

Options - Program 70

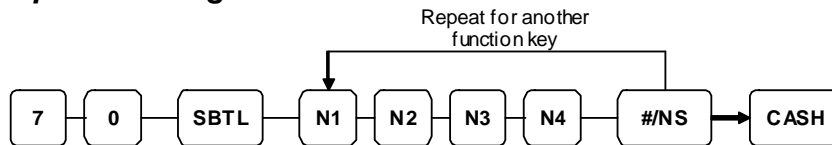

Address	OPTION	VALUE	=	SUM
N1	No Sale is inactive?	Yes = 1 No = 0		
	No Sale active in X control lock position only?	Yes = 2 No = 0		
	No Sale inactive after non-add # entry?	Yes = 4 No = 0		
N2	Enforce non-add # entry at start of sale?	Yes = 1 No = 0		
	Print when a NO SALE is performed?	Yes = 0 No = 2		
	Non-add # entries are prohibited?	Yes = 4 No = 0		
N3	Compulsory non-add entry must match number of digits set in the MAX DIGIT flag below?	Yes = 1 No = 0		
	Print non-add on guest check?	Yes = 2 No = 0		
N4	Enter maximum number of digits for non-add number entry. (0-8; Zero (0) means no limit).	0		

※Default values have been highlighted in **bold** print

Descriptor - Programs 80 & 81

Since two distinct functions, # entry and no sale, reside on the same key, different programs are used to program each descriptor.

To program the 'no sale' descriptor:

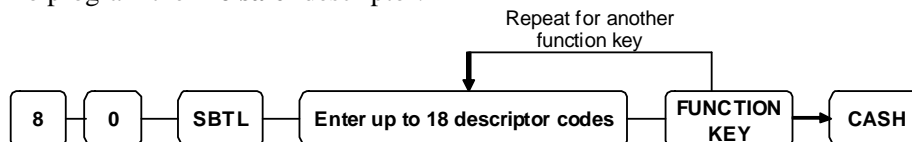

To program the '#(non add)' descriptor:

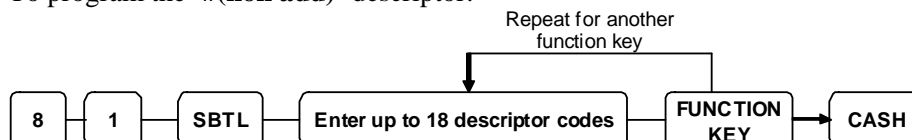

PAID OUT (1 ~ 3)

Options - Program 70

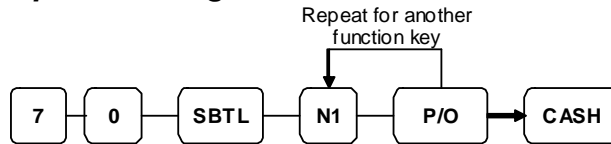

Address	OPTION	VALUE	=	SUM
N1	Key is inactive?	Yes = 1 No = 0		
	Key is active in X control lock position only	Yes = 2 No = 0		
	Validation is compulsory?	Yes = 4 No = 0		

※Default values have been highlighted in **bold** print

Descriptor - Program 80

- Refer to "Program 80 - Function Key Descriptor"

PAYMENT (Bill or Account)

Options - Program 70

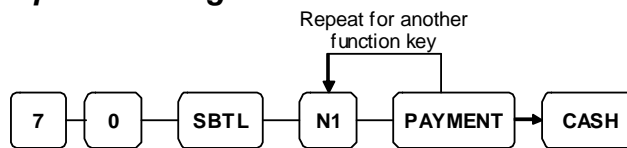

Address	OPTION	VALUE	=	SUM
N1	Required to close check?	Yes = 1 No = 0		

※Default values have been highlighted in **bold** print

Descriptor - Program 80

- Refer to "Program 80 - Function Key Descriptor"

PBAL (Bill or Account)

Options - Program 70

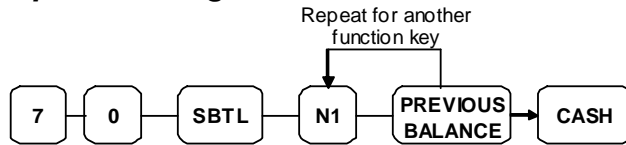

Address	OPTION	VALUE	=	SUM
N1	Previous balance may be entered at any time?	Yes = 1 No = 0		
	Previous balance required at the start of the sale?	Yes = 2 No = 0		
	Print on Guest Check (Soft) and Hard Check? (added on EPROM v5.8)	Yes = 4 No = 0		

※Default values have been highlighted in **bold** print

Descriptor - Program 80

- Refer to “Program 80 - Function Key Descriptor”

PRINT CHECK (Bill or Account)

Options - Program 70

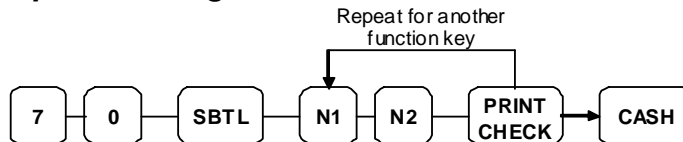

Address	OPTION	VALUE	=	SUM
N1	Enter Port Number. (Zero if the check will print on the receipt printer) (0-2)	0		
N2	Automatically Service Check?	Yes = 1 No = 0		
	Print Check on Receipt	Yes = 2 No = 0		
	Skip printing consecutive # on the guest check?	Yes = 4 No = 0		

※Default values have been highlighted in **bold** print

Descriptor - Program 80

- Refer to “Program 80 - Function Key Descriptor”

PROMO

Options - Program 70

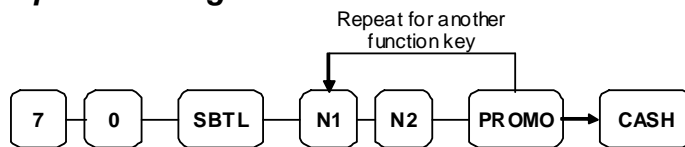

Address	OPTION	VALUE	=	SUM
N1	Key is inactive?	Yes = 1 No = 0		
	Key is active in X control lock position only?	Yes = 2 No = 0		
	Taxable by tax 1?	Yes = 4 No = 0		
N2	Taxable by tax 2?	Yes = 1 No = 0		
	Taxable by tax 3?	Yes = 2 No = 0		
	Taxable by tax 4?	Yes = 4 No = 0		

*Default values have been highlighted in **bold** print

Descriptor - Program 80

- Refer to "Program 80 - Function Key Descriptor"

RECD ON ACCT (1 ~ 3)

Options - Program 70

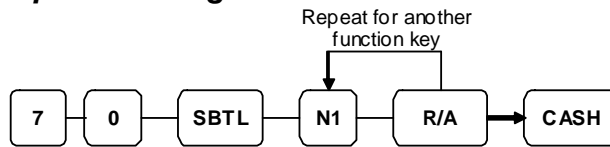

Address	OPTION	VALUE	=	SUM
N1	Key is inactive?	Yes = 1 No = 0		
	Key is active in X control lock position only?	Yes = 2 No = 0		
	Validation is compulsory?	Yes = 4 No = 0		

※Default values have been highlighted in **bold** print

Descriptor - Program 80

- Refer to "Program 80 - Function Key Descriptor"

HALO - Program 90

- Refer to "Program 90 - Function Key HALO"

SCALE

Options - Program 70

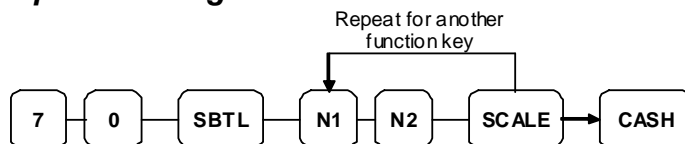

Address	OPTION	VALUE	=	SUM
N1	Key is inactive?	Yes = 1 No = 0		
	Key is active in X control lock position only?	Yes = 2 No = 0		
	Allow manual entry of weight?	Yes = 4 No = 0		
N2	Subtract tare weight on the scale entry?	Yes = 1 No = 0		
	Weight symbol for manual entry is:	Kg = 2		
		Lb = 0		
	Allow register scalable items by weight extension or by price entry?	Yes = 4 No = 0		

*Default values have been highlighted in **bold** print

Descriptor - Program 80

- Refer to "Program 80 - Function Key Descriptor"

SERVICE (Bill or Account)

Options - Program 70

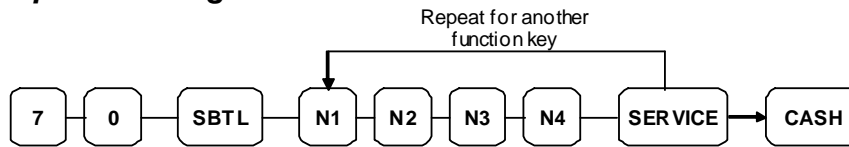

Address	OPTION	VALUE	=	SUM
N1	Compulsory non-add number before this key is used?	Yes = 1 No = 0		
	Print on receipt?	Yes = 0 No = 2		
	Allow negative balance in X control lock position only?	Yes = 4 No = 0		
N2	Calculate tax 1?	Yes = 0 No = 1		
	Calculate tax 2?	Yes = 0 No = 2		
	Calculate tax 3?	Yes = 0 No = 4		
N3	Calculate tax 4?	Yes = 0 No = 1		
	Validation is compulsory?	Yes = 2 No = 0		
N4	Enter the port number if you are using a hard check system. (0-2)	0		

※Default values have been highlighted in **bold** print

Descriptor - Program 80

- Refer to "Program 80 - Function Key Descriptor"

SUBTOTAL

Options - Program 70

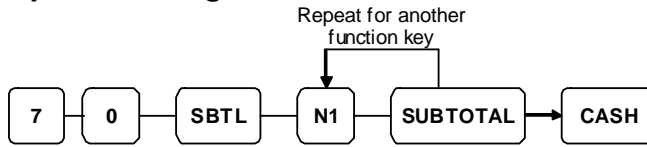

Address	OPTION	VALUE	=	SUM
N1	Key is inactive?	Yes = 1 No = 0		

※Default values have been highlighted in **bold** print

Descriptor - Program 80

- Refer to “Program 80 - Function Key Descriptor”

TABLE (Bill or Account)

Options - Program 70

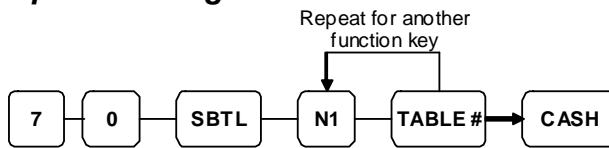

Address	OPTION	VALUE	=	SUM
N1	Table number entry compulsory before opening a new check?	Yes = 1 No = 0		
	Table number entry compulsory for all sales?	Yes = 2 No = 0		
	Print table# at the remote printer?	Yes = 4 No = 0		

※Default values have been highlighted in **bold** print

Descriptor - Program 80

- Refer to “Program 80 - Function Key Descriptor”

TARE

Options - Program 70

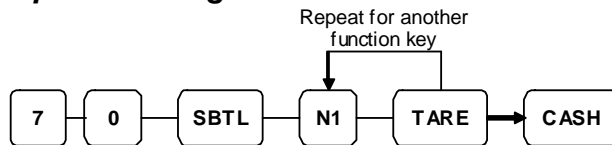

Address	OPTION	VALUE	=	SUM
N1	Key is inactive?	Yes = 1 No = 0		
	Key is active in X control lock position only?	Yes = 2 No = 0		
	Using tare number five to manually enter a tare weight?	Yes = 4 No = 0		

※Default values have been highlighted in **bold print**

Descriptor - Program 80

- Refer to "Program 80 - Function Key Descriptor"

TAX EXEMPT

Options - Program 70

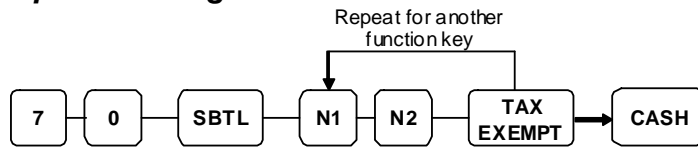

Address	OPTION	VALUE	=	SUM
N1	Exempt tax 1?	Yes = 1 No = 0		
	Exempt tax 2?	Yes = 2 No = 0		
	Exempt tax 3?	Yes = 4 No = 0		
N2	Exempt tax 4?	Yes = 1 No = 0		
	Compulsory non-add number before this key is used?	Yes = 2 No = 0		
	Validation is compulsory?	Yes = 4 No = 0		

※Default values have been highlighted in **bold** print

Descriptor - Program 80

- Refer to “Program 80 - Function Key Descriptor”

TIP (Bill or Account)

Options - Program 70

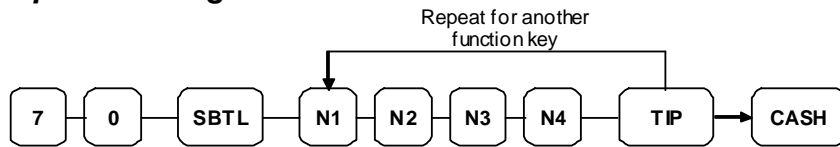

Address	OPTION	VALUE	=	SUM
N1	Type of tip is:	Percentage =	1	
		Amount =	0	
N2	Key is inactive?	Yes = 1 No = 0		
	Key is active in X control lock position only?	Yes = 2 No = 0		
	Add tax rate 1?	Yes = 4 No = 0		
N3	Add tax rate 2?	Yes = 1 No = 0		
	Add tax rate 3?	Yes = 2 No = 0		
	Add tax rate 4?	Yes = 4 No = 0		
N4	Add the tip total to the NET and GROSS sales total?	Yes = 1 No = 0		

※Default values have been highlighted in **bold** print

Descriptor - Program 80

- Refer to "Program 80 - Function Key Descriptor"

VALIDATE

Options - Program 70

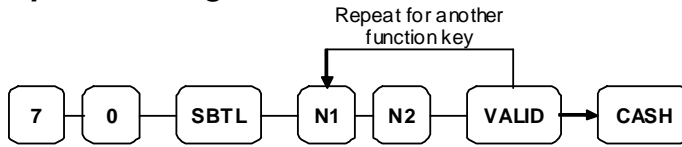

Address	OPTION	VALUE	=	SUM
N1	Enter Port Number. Enter 0 (zero) if validation is not used. (0-2)	0		
N2	Key is inactive?	Yes = 1 No = 0		
	Allow multiple validations?	Yes = 2 No = 0		

※Default values have been highlighted in **bold** print

Descriptor - Program 80

- Refer to “Program 80 - Function Key Descriptor”

VOID

Options - Program 70

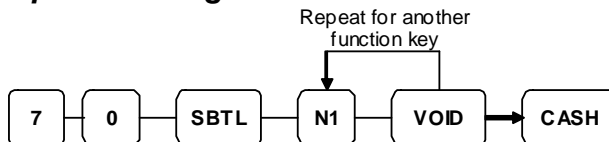

Address	OPTION	VALUE	=	SUM
N1	Key is inactive?	Yes = 1 No = 0		
	Key is active in X control lock position only?	Yes = 2 No = 0		
	Validation is compulsory?	Yes = 4 No = 0		

※Default values have been highlighted in **bold** print

Descriptor - Program 80

- Refer to “Program 80 - Function Key Descriptor”

HALO - Program 90

- Refer to “Program 90 - Function Key HALO”

WASTE

Options - Program 70

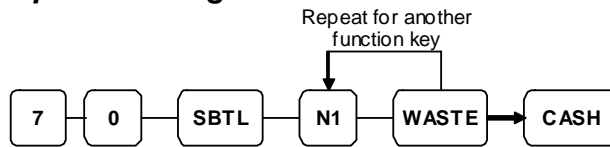

Address	OPTION	VALUE	=	SUM
N1	Key is inactive?	Yes = 1 No = 0		
	Key is active in X control lock position only?	Yes = 2 No = 0		
	Validation is compulsory?	Yes = 4 No = 0		

※Default values have been highlighted in **bold** print

Descriptor - Program 80

- Refer to "Program 80 - Function Key Descriptor"

HALO - Program 90

- Refer to "Program 90 - Function Key HALO"

% (1 ~ 5) (Discounts or Surcharges)

Options - Program 70

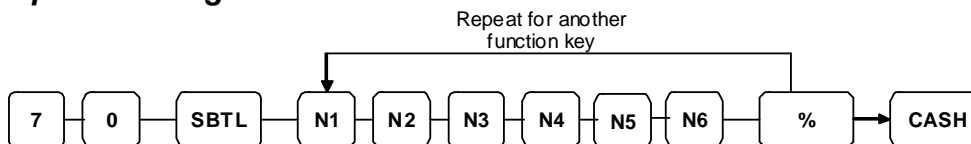

Address	OPTION	VALUE	=	SUM
N1	Apply an:	Amount =	1	
		Percentage =	0	
	Key is inactive?	Yes = 2 No = 0		
	% Key is active in X control lock position only?	Yes = 4 No = 0		
N2	% Key is:	Open =	1	
		Preset =	0	
	% Key is:	Sale =	2	
		Item =	0	
Allow % key override preset?	Yes = 4 No = 0			
N3	% Key is:	Positive =	1	
		Negative =	0	
	% Amount taxable tax 1?	Yes = 2 No = 0		
N4	% Amount taxable tax 2?	Yes = 1 No = 0		
	% Amount taxable tax 3?	Yes = 2 No = 0		
	% Amount taxable tax 4?	Yes = 4 No = 0		
N5	Reduce (or increase) the food stamp subtotal by % entry?	Yes = 1 No = 0		
	Allow only one time subtotal entry?	Yes = 2 No = 0		
	Allow multiple amount discounts (coupons) without pressing subtotal?	Yes = 4 No = 0		
N6	Allow % key preset override active in X control lock position only?	Yes = 1 No = 0		
	Validation is compulsory?	Yes = 2 No = 0		

※Default values have been highlighted in **bold** print

Descriptor - Program 80

- Refer to "Program 80 - Function Key Descriptor"

Preset % Rate - Program 90

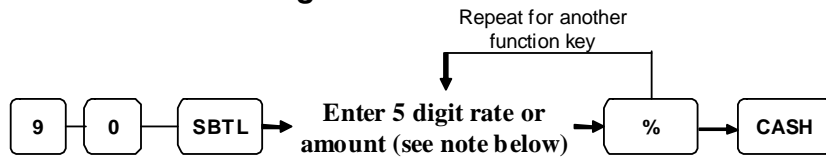

NOTE: If key is amount, enter 5 digit HALO, or 0 for no HALO. **If key is percentage enter the percentage in a five-digit format, without the decimal (XX.XXX).** For example: for 10%, enter 10000; for 5.55%, enter 05550; for 99.999%, enter 99999.

Clerk Programming

Clerks (which may be used as cashiers), have the following programming options. These options are set through separate programs:

- ***Program 800 - Secret Code programming*** determines the code that is used for clerk sign on if a code entry sign on method is selected in system option #2 (See "**System Option Programming**")
- ***Program 801 - Drawer Assignment & Training Clerk Programming***
- ***Program 810 - Clerk Description Programming*** allows you to set a unique, up to 18 character, descriptor for each clerk

Program 800 - Secret Code Programming

1. Turn the control lock to the **PGM-Mode**.
2. To begin the program, enter **8 0 0**, press the **SBTL** key.

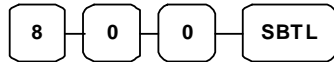

3. Enter the number of the clerk you wish to program; press the **X/TIME** key.



4. Enter a secret code (up to 6 digits); press the **SBTL** key.



5. Repeat from step 3 for each clerk you wish to program. Press the **CASH** key to finalize the program.



Program 801 - Drawer Assignment & Training Clerk Programming

1. Turn the control lock to the **PGM-Mode**.
2. To begin the program, enter **8 0 1**, press the **SBTL** key.

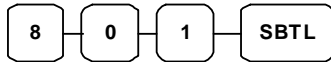

3. Enter the number of the clerk you wish to program; press the **X/TIME** key.



4. Enter an option digit from the table below, press the **SBTL** key.



Address	OPTION	VALUE	=	SUM
N1	Drawer assignment (0: default drawer, 1: no drawer)	1		
N2	Train Clerk	Yes = 1 No = 0		

※Default values have been highlighted in **bold** print

5. Repeat from step 3 for each clerk you wish to program. Press the **CASH** key to finalize the program.



NOTE: When set to '0' for default drawer, will show '1' on the Program Scan - Clerk Scan, '1' will show '2', '2' will show '0'.

Program 810 - Clerk Description Programming

Program descriptions by typing description on the alpha keyboard overlay or by entering three digit alpha character codes. **To use three digit alpha character codes you must select 'No' in system option #25** (See "System Option Programming). Also see **Descriptor Programming Methods for Alpha Overlay** and/or **Descriptor Code Table**.

1. Turn the control lock to the **PGM-Mode**.
2. To begin the program, enter **8 1 0**, press the **SBTL** key.

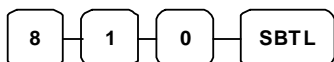

3. Enter the number of the clerk you wish to program; press the **X/TIME** key.

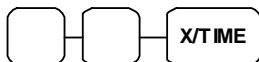

4. If you are programming using alpha overlay;

Type up to 18
descriptor keys → 

or,

Enter up to 18
three-character codes → 

5. Press the **CASH** key to finalize the program.



Mix & Match Programming

Mix & Match Tables have the following programming options. These options are set through separate programs:

- *Program 600 - Trip Level Programming*
- *Program 601 - Price Programming*
- *Program 610 - Mix & Match Description Programming* allows you to set a unique, up to 18 characters, descriptor for Mix & Match Table.

Program 600 - Trip Level Programming

1. Turn the control lock to the **PGM-Mode**.
2. To begin the program, enter **6 0 0**, press the **SBTL** key.

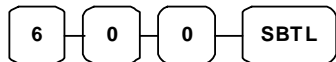

3. Enter the number of the M&M table you wish to program; press the **X/TIME** key.

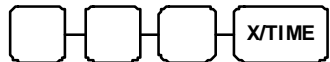

4. Enter a level of up to 5 digits (The Maximum Level you can enter is 30000) press the **SBTL** key.



5. Repeat from step 3 for each table you wish to program. Press the **CASH** key to finalize the program.

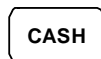

Program 601 - Price Programming

1. Turn the control lock to the **PGM-Mode**.
2. To begin the program, enter **6 0 1**, press the **SBTL** key.

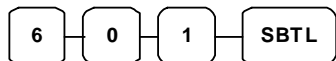

3. Enter the number of the M&M table you wish to program; press the **X/TIME** key.

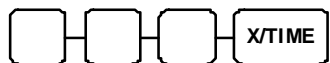

4. Enter a price (up to 7 digits); press the **SBTL** key.



5. Repeat from step 3 for each table you wish to program. Press the **CASH** key to finalize the program.

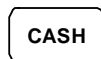

Program 610 - Mix & Match Description Programming

Program descriptions by typing description on the alpha keyboard overlay or by entering three digit alpha character codes. **To use three digit alpha character codes you must select 'No' in system option #25** (See "System Option Programming). Also see **Descriptor Programming Methods for Alpha Overlay** and/or **Descriptor Code Table**.

1. Turn the control lock to the **PGM-Mode**.
2. To begin the program, enter **6 1 0**, press the **SBTL** key.

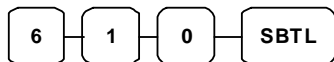

3. Enter the number of the M&M table you wish to program; press the **X/TIME** key.



4. If you are programming using alpha overlay,

Type up to 18
descriptor keys → 

or,

Enter up to 18
three-character codes → 

5. Press the **CASH** key to finalize the program.



Group Programming

20 Group totals are available to accumulate totals of individual PLUs that are assigned to each group. Each PLU can be assigned to one, two or three different groups.

- **Program 900 - Group Status Programming** allows to assign a group status, i.e. a group can be set to *not add* to the total of all groups, or a group can be used to designate like items for kitchen printer assignment.
- **Program 910 - Group Descriptors Programming** to assign a unique descriptor for each group, so that the group may be easily understood on the group report.

Program 900 - Group Status Programming

1. Turn the control lock to the **PGM-Mode**.
2. To begin the program, enter **9 0 0**, press the **SBTL** key.

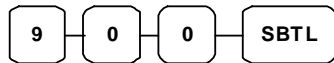

3. Enter the number of the group you wish to program; press the **X/TIME** key.



4. Enter an option digit from the table below, press the **SBTL** key.

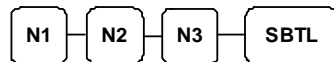

Address	OPTION	VALUE	=	SUM
N1	Group total is added to the total of all groups on the Group report?	Yes = 0 No = 1		
	Send to kitchen printer?	Yes = 2 No = 0		
N2	No Choice	0		
	KP PORT#: R (print a kitchen requisition)	1		
	KP PORT#: 1	2		
	KP PORT#: 2	4		
N3	Print RED on KP?	Yes = 1 No = 0		

*Default values have been highlighted in **bold** print

5. To program additional groups, repeat from step 3, or press the **CASH** key to finalize the program.



Program 910 - Group Descriptors Programming

Program descriptions by typing description on the alpha keyboard overlay or by entering three digit alpha character codes. **To use three digit alpha character codes you must select 'No' in system option #25 (See "System Option Programming").** Also see **Descriptor Programming Methods for Alpha Overlay** and/or **Descriptor Code Table**.

1. Turn the control lock to the **PGM-Mode**.
2. To begin the program, enter **9 1 0**, press the **SBTL** key.

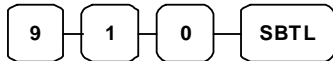

3. Enter the number of the group you wish to program; press the **X/TIME** key.

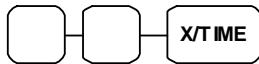

4. If you are programming using alpha overlay,

Type up to 18
descriptor keys → 

or,

Enter up to 18
three-character codes → 

5. To program additional groups, repeat from step 3, or press the **CASH** key to finalize the program.



Miscellaneous Programming

Program 1500 - Macro Key Sequence Programming

Macros are special function keys that are used to execute a sequence of key depressions. For example, a macro might be used to execute a string of reports or to automatically tender a preset amount. Up to ten different macros may be placed on the keyboard. (See "**Function Key Assignment Programming**" to place macros on the keyboard.)

To Program a Macro

1. Turn the control lock to the **PGM-Mode**.
2. To begin the program, enter **1 5 0 0**, press the **SBTL** key.

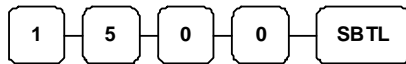

3. Press the **Macro** key that you wish to program.



4. First, you must change the Mode Key. Default Mode is PGM Mode.

Therefore, if you want to start in REG Mode, you must change Mode key to REG Mode.
Type up to 50 key strokes

Type up to 50 key strokes

5. Turn the control lock to the P position. Press the same **Macro** key to end the sequence



6. Repeat from step 3 - 5 to program additional macros. Press the **CASH** key to finalize the program.



To removing a Macro

If you wish to remove a keystroke from a macro, replace the current function with the **INACTIVE** function.

Program 700 - Logo Description Programming

Program descriptions by typing description on the alpha keyboard overlay or by entering three digit alpha character codes. **To use three digit alpha character codes you must select 'No' in system option #25** (See "System Option Programming). Also see **Descriptor Programming Methods for Alpha Overlay** and/or **Descriptor Code Table**.

Programming the Receipt/Check/Endorsement Message

A preamble message of up to six lines can be printed at the top of each receipt; a postamble message of up to six lines can be printed at the bottom of each receipt; an endorsement message of up to ten lines can be printed when a check is endorsed on an optional slip printer. Each line can consist of up to 32 characters.

1. Turn the control lock to the **PGM-Mode**.
2. To begin the program, enter **7 0 0**, press the **SBTL** key.

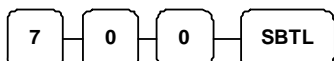

3. Refer to the chart below and enter the number that represents the line you wish to program; press the **X/TIME** key.

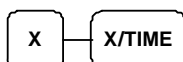

X	Message Line	X	Message Line
1	1 st line of Preamble	12	6 th line of Postamble
2	2 nd line of Preamble	13	1 st line of Endorsement
3	3 rd line of Preamble	14	2 nd line of Endorsement
4	4 th line of Preamble	15	3 rd line of Endorsement
5	5 th line of Preamble	16	4 th line of Endorsement
6	6 th line of Preamble	17	5 th line of Endorsement
7	1 st line of Postamble	18	6 th line of Endorsement
8	2 nd line of Postamble	19	7 th line of Endorsement
9	3 rd line of Postamble	20	8 th line of Endorsement
10	4 th line of Postamble	21	9 th line of Endorsement
11	5 th line of Postamble	22	10 th line of Endorsement

4. If you are programming using alpha overlay,

Type up to 32 descriptor keys → **SBTL**

or,

Enter up to 32 three-character codes → **SBTL**

5. Press the **CASH** key to finalize the program.



Program 701 - Financial Report Message Programming

Program descriptions by typing description on the alpha keyboard overlay or by entering three digit alpha character codes. **To use three digit alpha character codes you must select 'No' in system option #25** (See "System Option Programming). Also see **Descriptor Programming Methods for Alpha Overlay** and/or **Descriptor Code Table**.

Programming the Financial Report Message

The Financial Report selection allows you to reprogram the descriptors that appear with the Financial Report totals and counters. For example, the first total on the financial report "+PLU TTL" represents the total of all positive PLU entries. You might wish to re-label this total to say "FOOD SALES". You can reprogram any of the Financial Report totals listed here with any 18-character descriptor. (See "Financial Report Message").

1. Turn the control lock to the **PGM-Mode**.
2. To begin the program, enter **7 0 1**, press the **SBTL** key.

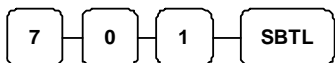

3. Refer to the chart below and enter the number that represents the line you wish to program; press the **X/TIME** key.

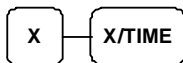

4. If you are programming using alpha overlay,

Type up to 18
descriptor keys → 

or,

Enter up to 18
three-character codes → 

5. Press the **CASH** key to finalize the program.



Financial Report Message

X	Message Line	X	Message Line	X	Message Line
1	+PLU TTL	29	CREDIT TAX4	57	CHG7-IN-D
2	-PLU TTL	30	FD/S CREDIT	58	CHG8-IN-D
3	ADJST TTL	31	RETURN	59	CHG1 SALES
4	NONTAX	32	ERROR CORR	60	CHG2 SALES
5	GST SALES	33	PREVIOUS VD	61	CHG3 SALES
6	TAX2 SALES	34	VOID MODE	62	CHG4 SALES
7	TAX3 SALES	35	CANCEL	63	CHG5 SALES
8	TAX4 SALES	36	GROSS SALES	64	CHG6 SALES
9	GST	37	CASH SALES	65	CHG7 SALES
10	TAX2	38	CHECK SALES	66	CHG8 SALES
11	TAX3	39	R/A 1	67	FOREIGN 1
12	TAX4	40	R/A 2	68	FOREIGN 2
13	XMPT1 SALES	41	R/A 3	69	FOREIGN 3
14	XMPT2 SALES	42	P/O 1	70	FOREIGN 4
15	XMPT3 SALES	43	P/O 2	71	DRWR TTL
16	XMPT4 SALES	44	P/O 3	72	PROMO
17	EATIN TTL	45	HASH TTL	73	WASTE
18	TAKEOUT TTL	46	AUDACTION	74	TIP
19	DRTHRU TTL	47	NOSALE	75	TRAIN TTL
20	% 1	48	CASH-IN-D	76	BAL FORWARD
21	% 2	49	CHECK-IN-D	77	GUESTS
22	% 3	50	FD/S-IN-D	78	P/BAL
23	% 4	51	CHG1-IN-D	79	CHECKS PAID
24	% 5	52	CHG2-IN-D	80	SERVICE
25	NET SALE	53	CHG3-IN-D	81	MIX&MATCH
26	CREDIT GST	54	CHG4-IN-D	82	ROUND TTL
27	CREDIT TAX2	55	CHG5-IN-D	83	CASH OUT
28	CREDIT TAX3	56	CHG6-IN-D		

Program 710 - Clerk Report Message Programming

Program descriptions by typing description on the alpha keyboard overlay or by entering three digit alpha character codes. **To use three digit alpha character codes you must select 'No' in system option #25** (See "System Option Programming). Also see **Descriptor Programming Methods for Alpha Overlay** and/or **Descriptor Code Table**.

Programming the Clerk Report Message

The Clerk Report selection allows you to reprogram the descriptors that appear with the Clerk Report totals and counters. For example, the first total on the clerk report "NET SALES" might be re-labeled to say "GROSS SALES". You can reprogram any of the Financial Report totals listed here with any 18-character descriptor. (See "Clerk Report Message").

1. Turn the control lock to the **PGM-Mode**.
2. To begin the program, enter **7 1 0**, press the **SBTL** key.

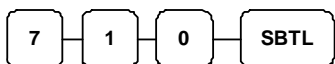

3. Refer to the chart below and enter the number that represents the line you wish to program; press the **X/TIME** key.

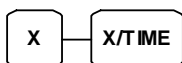

4. If you are programming using alpha overlay,

Type up to 18 descriptor keys → SBTL

or,

Enter up to 18 three-character codes → SBTL

5. Press the **CASH** key to finalize the program.



Clerk Report Message

X	Message Line	X	Message Line	X	Message Line
1	NET SALE	25	CREDIT TAX3	49	CHG4 SALES
2	NONTAX	26	CREDIT TAX4	50	CHG5 SALES
3	GST SALES	27	FD/S CREDIT	51	CHG6 SALES
4	TAX2 SALES	28	RETURN	52	CHG7 SALES
5	TAX3 SALES	29	ERROR CORR	53	CHG8 SALES
6	TAX4 SALES	30	PREVIOUS VD	54	FOREIGN 1
7	GST	31	VOID MODE	55	FOREIGN 2
8	TAX2	32	CANCEL	56	FOREIGN 3
9	TAX3	33	GROSS SALES	57	FOREIGN 4
10	TAX4	34	CASH SALES	58	DRWR TTL
11	XMPT1 SALES	35	CHECK SALES	59	PROMO
12	XMPT2 SALES	36	R/A 1	60	WASTE
13	XMPT3 SALES	37	R/A 2	61	TIP
14	XMPT4 SALES	38	R/A 3	62	TRAIN TTL
15	EATIN TTL	39	P/O 1	63	BAL FORWARD
16	TAKEOUT TTL	40	P/O 2	64	GUESTS
17	DRTHRU TTL	41	P/O 3	65	P/BAL
18	% 1	42	HASH TTL	66	CHECKS PAID
19	% 2	43	CASH-IN-D	67	SERVICE
20	% 3	44	CHECK-IN-D	68	CASH OUT
21	% 4	45	FD/S-IN-D	69	NOSALE
22	% 5	46	CHG1 SALES	70	MIX&MATCH
23	CREDIT GST	47	CHG2 SALES		
24	CREDIT TAX2	48	CHG3 SALES		

Program 711 - Macro Name Programming

Program descriptions by typing description on the alpha keyboard overlay or by entering three digit alpha character codes. **To use three digit alpha character codes you must select 'No' in system option #25** (See "System Option Programming"). Also see **Descriptor Programming Methods for Alpha Overlay** and/or **Descriptor Code Table**.

Programming the Macro Name

Up to ten function locations may be designated as Macro keys. You may wish to program a name for a macro. For example if a macro executes a series of commands to produce daily reports, you can program the descriptor "DAILY", so the macro can easily be identified. Macro names can also be helpful when looking at keyboard layout information with the PC communication utility.

1. Turn the control lock to the **PGM-Mode**.
2. To begin the program, enter **7 1 1**, press the **SBTL** key.

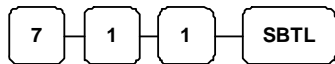

3. Refer to the chart below and enter the number that represents the line you wish to program; press the **X/TIME** key.



X	Macro Key	X	Macro Key
1	Macro 1	6	Macro 6
2	Macro 2	7	Macro 7
3	Macro 3	8	Macro 8
4	Macro 4	9	Macro 9
5	Macro 5	10	Macro 10

4. If you are programming using alpha overlay,

Type up to 18 descriptor keys → 

or,

Enter up to 18 three-character codes → 

5. Press the **CASH** key to finalize the program.

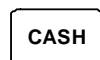

Program 1000 - NLU (Number Look Up) Code Number Programming

NLU (Number Look Up) are fixed keys on the keyboard (like traditional department keys) that access specific PLUs.

On the default keyboard, there are 117(ER-5200/M)/40(ER-5240/M)/15(ER-5215/M) NLU keys and the PLU# assigned to the NLU key is the same, i.e. NLU key #1 is assigned by PLU #1. However, with this program, you can assign any PLU number you wish to any one of the possible (117 (ER-5200/M) / 40 (ER-5240/M) / 15 (ER-5215/M)) NLU keys.

Programming the NLU Code Number

1. Turn the control lock to the **PGM-Mode**.
2. To begin the program, enter **1 0 0 0**, press the **SBTL** key.

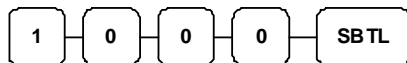

3. Type the new PLU code number you wish to use for this NLU key, and Press the NLU key on the keyboard you wish to program, and Press the NLU key again.

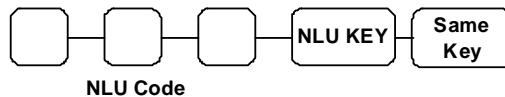

4. Press **CASH** to finalize the program



Program 1100 - Cash-In-Drawer Limit Programming

You can set a limit for cash in drawer. When cash in drawer exceeds the limit you program here, a warning will display on the screen. You must press CLEAR to remove the warning and continue operations. The warning will continue to appear at the completion of every transaction with the limit exceeded, until you use the PAID OUT function to remove cash from the drawer.

Programming the Drawer Limit

1. Turn the control lock to the **PGM-Mode**.
2. To begin the program, enter **1 1 0 0**, press the **SBTL** key.

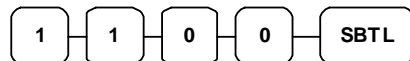

3. Enter a cash-in-drawer limit (up to 8 digits or **0** for no limit); press the **X/TIME** key.

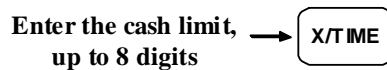

4. Press the **CASH** key to finalize the program.

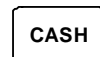

Program 1200 - Check Change Limit Programming

Use this program to set the maximum amount of cash that can be returned when a check is tendered for an amount greater than the amount of the sale. For example, if the check change limit is \$10.00 the maximum amount that can be tendered into the check key on a \$5.00 sale is \$15.00.

Programming the Check Change Limit

1. Turn the control lock to the **PGM-Mode**.
2. To begin the program, enter **1 2 0 0**, press the **SBTL** key.

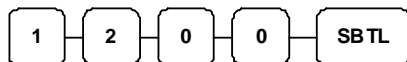

3. Enter a cash-in-drawer limit (up to 8 digits or **0** for no limit); press the **X/TIME** key.

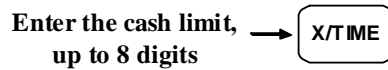

4. Press the **CASH** key to finalize the program.



Program 1300 - Date and Time Programming

Use this program to set the clock and calendar on your *ER-5200/ER-5200M Series*. The date changes automatically. After initial setting, time changing will probably be required only for beginning and ending daylight savings time.

Programming the Date and Time

1. Turn the control lock to the **PGM-Mode**.
2. To begin the program, enter **1 3 0 0**, press the **SBTL** key.

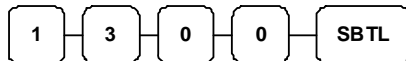

3. Enter time in military standard time (based on 24 hours), must be four digits (i.e. 1300 hours = 1:00 PM); press the **X/TIME** key.

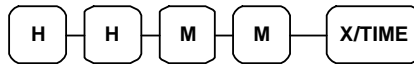

4. Enter the date in MM (month) DD (day) and YY (year) format. Press the **X/TIME** key:



5. Press the **CASH** key to finalize the program.



Program 1400 - Scale Tare Weight Programming

A tare is the amount of weight representing the container, or package when items are sold by weight. You can pre-program five tare weights, representing the weight of different containers. When you place an item and a container on optional scale, you can enter the tare number to automatically subtract the pre-programmed tare weight. If you choose to use tare #5 for manual tare weight entry, do not enter a weight for tare #5. (See TARE.)

Programming the Scale Tare Weight

1. Turn the control lock to the **PGM-Mode**.
2. To begin the program, enter **1 4 0 0**, press the **SBTL** key.

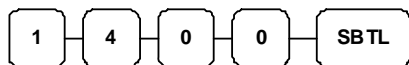

3. Enter the number (**1-5**) of the tare you wish to program; press the **X/TIME** key.

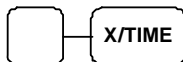

4. Enter the weight of the tare (one digit preceding the decimal key, the decimal key, then three digits after the decimal key). Press the **SBTL** key.



5. To program additional tare weights, repeat from step 3, or press the **CASH** key to finalize the program.



Program 1600 - Machine Number Programming

The machine number is printed on the register receipt. Program a machine number so that any receipt can be identified with the store or register where the transaction took place.

Programming the Machine Number

1. Turn the control lock to the **PGM-Mode**.
2. To begin the program, enter **1 6 0 0**, press the **SBTL** key.

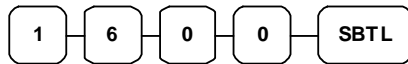

3. Enter a machine number (up to 5 digits); press the **X/TIME** key.

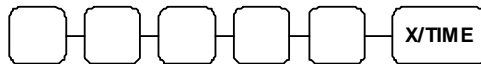

4. Press the **CASH** key to finalize the program.



Program Scans

Since much time and energy has been invested in the planning and programming of your *ER-5200/ER-5200M series*, it is advisable to print a hard copy of the final program for future reference. This copy should be kept in a safe place.

Program 15 - Program Scans

1. Turn the control lock to the **PGM-Mode**.
2. To print a program scan, enter **1 5**, press the **SBTL** key.

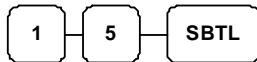

3. In this step, there are three different ways to scan program information. One is PLU, the other is Macro, and the third is Others.

PLU PROGRAM SCAN

- To read single PLU program information, enter the number (1-1000) of the PLU and press the same number and PLU key.

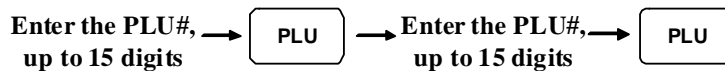

- Press a PLU key on the keyboard and press same key again.



- To read multiple PLU program information, enter the first number (1-1000) and press PLU key. Press the last number (1-1000) and press PLU key

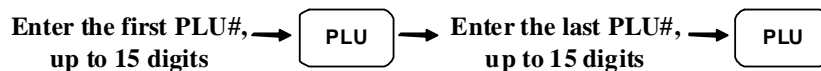

- Press a PLU key on the keyboard.



MACRO PROGRAM SCAN

- To read MACRO information, press the MACRO key to be scanned,



OTHERS PROGRAM SCAN

Refer to the chart below and enter a digit to represent the segment of the program you wish to print; press the **X/TIME** key. To see additional scan, repeat this operation.

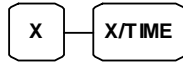

X	Program	X	Program
0	Group	9	Financial Report message
1	Tax	10	Clerk Report message
2	System option	11	Macro Name
3	Print option	12	Drawer Limit
4	Function keys	13	Check Change Limit
5	Clerk	14	Time & Date
6	Preamble message	15	Tare Weight
7	Postamble message	16	Machine Number
8	Endorsement message	17	Mix & Match

NOTE: When **X** is **4** for function key scan, please press the function key you want to scan after **X/TIME** button. When features on **more than one function keys** are going to be scanned, repeat “**4** then **X/TIME**” followed with next function key.

4. Press the **CASH** key to finalize the program.



Sample Reports

Financial

WARNING!! X or Z Report	DATE 15/01/2003 WED TIME 13:32	
	X 1 REPORT	00001

	FINANCIAL	
Total and count of all positive PLUs	+PLU TTL	179.56
		\$288.60
Total and count of all Negative PLUs	-PLU TTL	10
		-20.00
	ADJST TTL	189.56
		\$268.60

Total of +PLU and -PLU sales	NONTAX	\$30.47
Total of Non-taxable sales	GST SALES	\$153.60
PLU number	TAX2 SALES	\$11.92
	TAX3 SALES	\$16.77
	TAX4 SALES	\$31.89
	GST	\$10.00
	TAX2	\$1.21
	TAX3	\$1.18
Number of items sold in all groups.	TAX4	\$2.18
	XMPT1 SALES	\$7.00
	XMPT2 SALES	\$1.50
Total exempted sales for each tax	XMPT3 SALES	\$7.95
	XMPT4 SALES	\$7.50
	EATIN TTL	1
		\$10.12
Total sales for each type of destination	TAKEOUT TTL	2
		\$40.77

continued . . .

Total sales for each type of destination

Total and count for each % function key (i.e. discounts & coupons)

Net Sales

Credited tax for each tax. (Tax is credited for negative taxable sales, i.e. mdse return transactions.)

Food stamp change credited to sales

Total and count for each type of transaction correction.

Gross Sales

Totals and counters for CASH and CHECK sales

Total and count for each type R/A (received on account) and P/O (paid out) key.

continued from previous page

DRTHRU TTL	1	
		\$3.04
ITEM DISC.	3	
		-0.48
SALE DISC.	2	
		-5.22
SALE SURCH.	3	
		\$3.23
% 4	0	
		\$0.00
% 5	0	
		\$0.00
NET SALE	26	
		\$281.18
CREDIT GST	4	
		-1.11
CREDIT TAX2	1	
		-0.23
CREDIT TAX3	2	
		-0.89
CREDIT TAX4	1	
		-0.39
FD/S CREDIT	0	
		\$0.23
RETURN	33	
		-59.73
ERROR CORR	2	
		-4.00
PREVIOUS VD	1	
		-1.50
VOID MODE	-2	
		-6.40
CANCEL	2	
		\$16.00
GROSS SALES		\$375.63
CASH SALES	13	
		\$133.49
CHECK SALES	1	
		\$23.05
R/A 1	1	
		\$145.00
R/A 2	0	
		\$0.00

continued . . .

Total and count for each type R/A (received on account) and P/O (paid out) key.

Total and count of items sold with HASH status.

Count of No Sales.

Total of numbers entered into the non-add key

Total and count of expected CASH, CHECK in drawer

Total and count for each CHARGE in drawer.

Total and count for each CHARGE key.

continued from previous page

R/A 3	0
	\$0.00
P/O 1	1
	-140.00
P/O 2	0
	\$0.00
P/O 3	0
	\$0.00
HASH TTL	0
	\$0.00
NOSALE	4
NON ADD #	547
CASH-IN-D	14
	\$269.99
CHECK-IN-D	3
	-108.45
FD/S-IN-D	2
	\$21.00
CHG1-IN-D	0
	\$0.00
CHG2-IN-D	1
	\$8.43
CHG3-IN-D	1
	\$8.52
CHG4-IN-D	2
	-1.60
CHG5-IN-D	1
	\$2.67
CHG6-IN-D	2
	\$13.09
CHG7-IN-D	0
	\$0.00
CHG8-IN-D	1
	\$0.00
CHG1 SALES	0
	\$0.00
CHG2 SALES	1
	\$8.43
CHG3 SALES	1
	\$8.52
CHG4 SALES	2
	-1.60
CHG5 SALES	1
	\$2.67

continued . . .

continued from previous page

Total and count for each CHARGE key.	CHG6 SALES	2	
		\$13.09	
	CHG7 SALES	0	
		\$0.00	
Total for each Foreign currency in drawer.	CHG8 SALES	1	
		\$3.04	
Total of CASH, CHECKS and CHARGES in drawer.	FOREIGN 1	0.00	
	FOREIGN 2	0.00	
	FOREIGN 3	0.00	
	FOREIGN 4	0.00	
Total and count for PROMO, WASTE and TIPS.	DRWR TTL	\$216.69	
	PROMO	1	
		\$1.50	
Number of transactions and total activity in Training Mode	WASTE	8	
		\$12.50	
	TIPS	0	
		\$0.00	
Total and count of all balances serviced	TRAIN TTL	5	
		\$62.59	
Total number of guests served	BAL FORWARD	4	
		\$88.13	
Total and count of balances entered into PBAL key	GUESTS	5	
	P/BAL	4	
Total and count of balances paid		\$0.00	
Total and count of items serviced	CHECKS PAID	2	
		\$18.64	
Total and count of mix & match disc.	SERVICE	4	
		\$88.13	
Average number if items per customer, and average dollar sales per customer	MIX&MATCH	0	
		\$0.00	
Grand total	AVG ITEM/CUST	7.29	
	AVG \$/CUST	\$10.81	

		*	
	GRAND	\$375.63	
	ETHAN	000209 00000	

Time

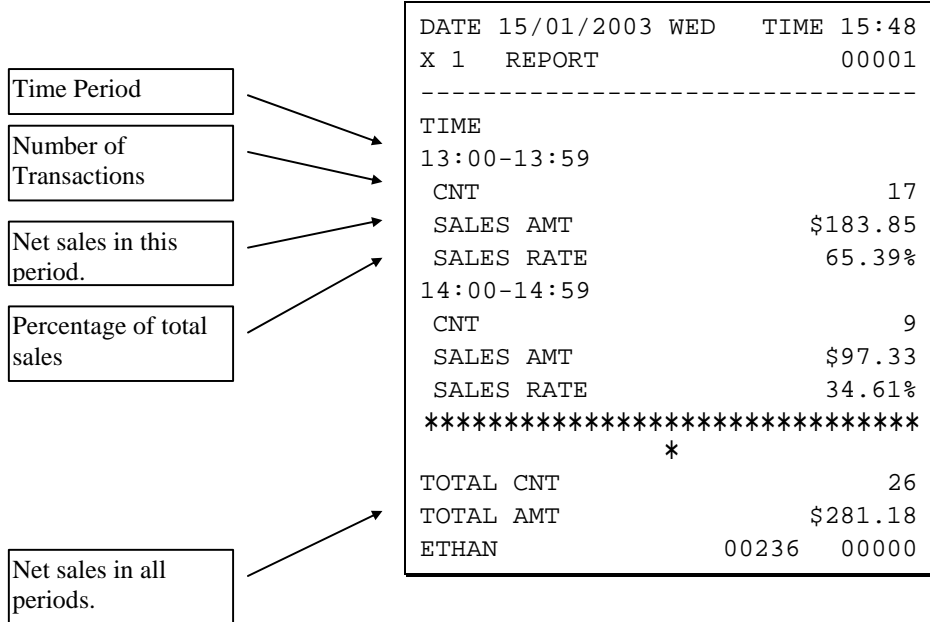

PLU

PLU number or
PLU descriptor

Count and sales
total.

Percentage of total
sales (optional)

Total activity for all
PLUs

Total sales for all
PLUs.

```

DATE 15/01/2003 WED    TIME 15:33
X 1  REPORT              00001
-----
ALL PLU
HAMBURGER
  CNT 28                  $42.00
  SALES RATE              15.64%
DBL BURGER
  CNT 40                  $99.75
  SALES RATE              37.14%
COKE
  CNT 26                  $38.85
  SALES RATE              14.46%
SPRITE
  CNT 18                  $13.42
  SALES RATE              5.00%
ROAST
  CNT 19.16              $30.47
  SALES RATE              11.34%
UNLEADED
  CNT 32.85              $39.39
  SALES RATE              14.66%
RETURNS
  CNT 10                  -20.00
  SALES RATE              -7.44%
PLU#33
  CNT 15.55              $24.72
  SALES RATE              9.20%
*****
                                *
TOTAL CNT                  189.56
TOTAL AMT                  $268.60
ETHAN                      000213  00000
    
```

Clerk

NOTE: Media totals can be printed for each clerk, if selected in **System Option Programming**.

Clerk Name	→	DATE 15/01/2003 WED	TIME 15:36
Number of Transactions	→	X 1 REPORT	00001
Net sales for this clerk	→	-----	
Drawer total for this clerk	→	ALL CLERK	
		ETHAN	
		NET SALE	10
			\$155.23
		DRWR TTL	\$109.81

		ZACH	
		NET SALE	5
			\$45.14
		DRWR TTL	\$43.22

		ANNA	
		NET SALE	4
			\$78.75
		DRWR TTL	\$67.03

		LAURA	
		NET SALE	2
			\$0.00
		DRWR TTL	\$18.64

		PEGGY	

		MOLLY	
		NET SALE	5
			\$2.06
		DRWR TTL	-22.01

		ETHAN	000218 00000

Individual Clerk

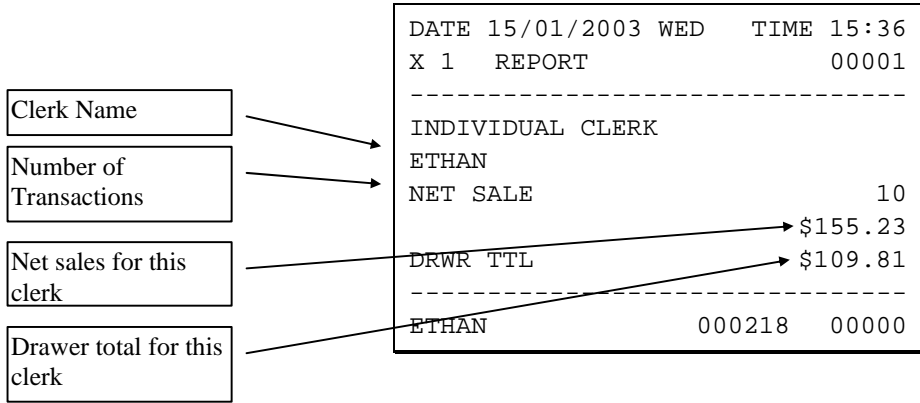

Groups

Group Descriptor

Number of items sold in this group

Net sales for this group

```

DATE 15/01/2003 WED    TIME 15:34
X 1  REPORT              00001
-----
GROUP
GROUP : 1 FOOD
  CNT                      68
  SALES AMT                 $141.75
GROUP : 2 DRINK
  CNT                      44
  SALES AMT                 $52.27
GROUP : 3 REST.
  CNT                      112
  SALES AMT                 $194.02
GROUP : 5 STORE
  CNT                      19.16
  SALES AMT                 $30.47
GROUP : 8 MDSE
  CNT                      58.40
  SALES AMT                 $44.11
GROUP : 9 STORE MDSE
  CNT                      77.56
  SALES AMT                 $74.58
*****
                          *
TOTAL CNT                  189.56
TOTAL AMT                  $268.60
ETHAN                      000237  00000
  
```

Net sales for all groups.

Stock

PLU number or
PLU descriptor

Current Stock count

```
DATE 15/01/2003 WED    TIME 15:47
X 1  REPORT              00001
-----
ALL PLU STOCK
HAMBURGER
  CNT                      26
DBL BURGER
  CNT                      15
ROAST
  CNT                    25.96
UNLEADED
  CNT                   1488.47
PLU33
  CNT                    161.25
ETHAN                      000228  00000
```

Open Check

Open check number
and balance.

Clerk responsible
for the check.

DATE	15/01/2003 WED	TIME	15:59
X 1	REPORT		00001

OPEN CHECK			
CHECK :	3		\$24.07
TABLE :	15		
MOLLY			
CHECK :	4		\$45.42
TABLE :	8		
ETHAN			
CHECK :	5		\$24.50
TABLE :	2		
ETHAN			
CHECK :	6		\$28.33
TABLE :	6		
ETHAN			
ETHAN		000243	00000